

Gripper

About the product	6
2 Finger Parallel Grippers	30
AF101 (Rack & Pinion Type)	30
AF02 (Rack & Pinion Type)	36
AF04P (Link Lever Type)	46
AF105P (Roller Guide Type)	52
AF10 (Rack & Pinion Type)	58
AF13 (Rack & Pinion Type)	64
AF13C (Rack & Pinion Type)	74
AF14 (Taper Roller Guide Type)	80
AF15 (Rack & Pinion Type)	86
AF316 (Cross Roller Guide Type)	92
AF28D (Link Lever Type)	98
AF30 (Wedge Type)	106
AF30SP (Special Wedge Type)	116
AF30DP (Dust-Proof Type)	122
Centric Grippers	128
AF26 (Link Lever Type)	128
AF46 (Wedge Type)	138
AF46DP (Dust-Proof Type)	148
AF56N (Wedge Type)	154
Angular Grippers	164
AF03 (Link Lever Type)	164
AF06 (Link Lever Type)	170
AF17 (Rack & Pinion Type)	176
AF117 (Crank Lever Type)	182
AF19 (Cam Roller Type)	192
AF24 (Link Lever Type)	196
Air Chuck	204
AF40 (Wedge Guide Type)	204
Grip & Rotate	210
RAF56N (Wedge Guide Type)	210
Mechanical Gripper	216
MF16 (Mechanical Type)	216

About the Product

The Gripper is like the fingers of a man, picking up and placing objects vertically or horizontally. You can select appropriate products according to the object's weight and shape.

1. Definition of an Gripper

There is no definition of the Gripper in the stipulations of the KS. However, the Gripper could be defined as follows when the definition of the industrial robot according to the JIS BO314-1986, which is the stipulation of the Japanese industries, is used:

- (1) 2023: Parts that have functions similar to the man's hands (hands, mechanical hands)
- (2) 2024: Parts that can grasp and pull objects (Grippers)
- (3) We decided to call the pneumatic actuators that pertain to the above definitions as Grippers, classifying products by shape.

As a result, the concept of "finger" as defined by the JIS came be called the JAW.

2. Classification of the Gripper

Classification according to the power supply

- (1) Standard method: The standard method is the method in which opening and closing operations are carried out by air pressure. Some producers call this method double operating type (D.O.), but generally, the method is not denoted.
- (2) Simple method: One of either the opening or closing operation is carried out by the spring. The method is used for the prevention of the dropping of objects when the air is intercepted or for preventing interactions of peripheral attachments. The method could be distinguished by the Normally Open (NO) and Normally Close (NC) types.
- (3) Complex method: The method utilizes the power of both pressurized air and spring in order to resolve the cross-sectional differences. The method is used mostly when the object's weight is substantial. We install the air port under the simple method as well in order to utilize the air power.

Classification by the size of the cylinder

- (1) Small: The diameter of the piston is around and used primarily to grip low weight objects.
- (2) Medium: The diameter of the piston is around and used primarily to grip objects that weigh around.
- (3) Large: The diameter of the piston is more than and used to grip objects that weigh more than.

Classification by movement

- (1) Open & close type by angle: The type in which the jaw revolves with the hinge as center
- (2) Parallel open & close type: The type in which the jaw moves in parallel

Gripper

Classification by movement structure

(1) Operational method: Movement of a jaw is linked to the movement of the jaw in the opposite side to enable centering. Rack & pinion or link could be used.

Generally, the link type doesn't guarantee durability due to internal wear and tear although the initial operation is smooth.



(2) Roller Guide Type: The tapered roller guide is moved by the roller to open and close the jaw. The method is applied usually to small Grippers and the product quality depends on the production precision.



(3) Link Lever Type: This is the simplest method. Only the hinge is fixed to change the linear movement and rotary movement.

Although the method is inexpensive and the structure is simple, wear and tear of a part by the line contact could occur depending on the difference in the hardness of the surface of the part that is subject to wear and tear. As a result, the method is applied to small products. This is the general method for angular close and open types. Also, the link moves rotationally, resulting in the change in the gripping power according to the location of the jaw.



(4) Crank Lever Type: This is the type in which there are more than 2 hinge points and the rotational movement and linear movement take place interchangeable. Compared to the link lever type, the type is more precise, but minuscule amount of eccentricity could occur depending on the precision of production. Also, for the angular open and close type, the volume becomes relatively large.



Gripper

(5) Rack & Pinion Type: This is the type in which linear movement and rotational movement occur interchangeably using the basic rack & pinion. The method is used mainly for medium and large products. Due to the mutual cloud movements, the type is highly resistant to wear and tear, but backlashes could occur due to the cutting state. Also, due to the 1:1 operational method, there is no change in the gripping power as the location of the jaw changes.



(6) CAM Type: The type is used for small products. Geometrical CAM is used, and as a result, the production cost is high. Also, due to the problem of wear and tear, the type cannot be applied readily to medium and large products.



(7) Wedge type: The type is pursued by a lot of domestic and foreign pneumatic equipment manufacturers including us. This is a method in which the direction of movement is changed by sliding the taper-processed side of the dovetail method. By enlarging the contact side, the wear and tear problem could be resolved. Furthermore, the method doesn't generate substantially greater power than Grippers of different structures with identical cylindrical cross sections. Because the movement depends on the precision of parts that are put together, a heavy reliance on the processing technology is inevitable.



Others

(1) Other than the methods enumerated above, there are cross roller and sliding bush methods, classified according to the guide type of the jaw.

(2) Classifications by the number of jaws, such as 2 jaws, 3 jaws, 4 jaws, etc. could be possible.

3. How to select Grippers

Things to consider when selecting an Gripper

(1) The direction of movement after gripping

(2) Causes of the increase or decrease of required gripping power according to the movement

(3) External power exerted to objects to be gripped

(4) Review of optimal gripping type in the production process

(5) Calculation of allowable gripping power

(6) Selection of appropriate size according to the classification of air fingers

(7) Review of the appropriateness of selected air fingers

Caution when applying Grippers

(1) Grippers should be selected by considering the weight, inertia, and gripping type of the object to be gripped. If possible, move the object to be gripped near the Grippers to decrease the momentum. Also, when the outer edge of the object is being gripped, make sure that the area of the attachment that extrudes more than the Gripper body should be designed smaller.

(2) For small Grippers, there are products for which the attachment of the reed switch could be impossible. Even if the attachment is possible, the attachment could extrude outside the Grippers. Therefore, care should be taken when designing.

(3) Under certain conditions, the magnetic power built into the cylinder decreases, causing the switching to malfunction. Therefore, it is advised that nonmetallic materials be used for stainless bolts and mounting plates.

(4) When air is not being supplied or when the object has not been gripped, a problem of the jaw could occur. However, when the object has been gripped, no problem occurs.

(5) It is structurally impossible to determine the state of the product by operating the jaw with hands while the air is not supplied. Therefore, it's difficult to compare the product with other products.

(6) When producing a NO or NC type according to the spring, the length of the Gripper body could become longer. Therefore, care is required. The power of the spring changes according to the length of contraction. Therefore, notify us of the rough scope of the opening and closing of the object to be gripped.

(7) When gripping unusual objects, it would be better to inquire us to custom design a product rather than to apply the standard. We will consult with you regarding the delivery date and price.

(8) When using products that use the switch, the dock plate that inspects sensors could protrude to the side of the Gripper body. Also, order either the PNP or NPN method according to the diode connection method when we attach the sensor.

(9) When you use our products and when you use the required outer blueprint, we provide the blueprint based on the AUTOCAD-2000(*DWG) criteria. Also, when you provide us with the layout of the applicable part and the product in a file format, our technological sales department will provide support to minimize problems.

Gripper

Caution when applying Gripper

1) Forces and Moment : Max allowable forces and moments on jaws.

Product Name	Fa (N)	Mp (Nm)	My (Nm)	Mr (Nm)	Page
AF101-10N	24	19.6	11.8	7.8	30
AF101-12	32	17.7	10.6	7.6	30
AF02-16	52	17.5	10.5	10.5	36
AF02-20	85	15.8	9.5	12.6	36
AF02-30	235	39.2	23.5	23.5	36
AF02-40	673	70.2	42.1	48.1	36
AF02-63	1270	105.8	63.5	66.8	36
AF04P-12N	26	21.0	13.0	9.0	46
AF04P-16	39	21.0	13.0	11.0	46
AF04P-20	59	25.0	15.0	15.0	46
AF105P-8	19	13.0	8.0	6.0	52
AF105P-10	30	16.0	10.0	8.0	52
AF105P-16	65	27.0	16.0	12.0	52
AF10-20	35	10.0	6.0	4.3	58
AF10-30	115	22.6	13.6	10.5	58
AF10-40	135	20.0	12.0	9.0	58
AF10-50	140	22.0	14.0	11.0	58
AF13-20	43	10.0	6.0	12.0	64
AF13-30	103	19.0	11.0	21.0	64
AF13-40	156	24.0	14.0	27.0	64

Gripper

Caution when applying Gripper

Forces and Moment : Max allowable forces and moments on jaws.

Product Name	Fa (N)	Mp (Nm)	My (Nm)	Mr (Nm)	Page
AF13-50	280	35.8	21.5	40.4	64
AF13-63	530	62.8	37.7	62.0	64
AF13-80	850	93.4	56.0	80.1	64
AF13-100	1200	99.2	60.0	93.8	64
AF13C-20	45	10.2	6.1	11.9	74
AF13C-30	100	19.1	11.4	20.6	74
AF13C-40	150	23.7	14.2	27.0	74
AF13C-50	280	35.8	21.5	40.4	74
AF14-20	200	49.3	29.6	57.5	80
AF14-30	350	74.0	44.4	72.5	80
AF15-12	25	6.9	4.2	5.7	86
AF15-16	45	10.7	6.4	8.7	86
AF15-20	90	16.4	9.9	12.3	86
AF316-16	40	13.9	8.3	17.4	92
AF316-20	130	32.4	19.5	39.5	92
AF316-25	190	40.2	24.1	45.9	92
AF28D-10	10	8.2	4.9	1.5	98
AF28D-14	20	10.9	6.5	2.5	98
AF28D-16	24	11.1	6.5	2.7	98
AF28D-20	34	12.4	6.8	3.1	98

Gripper

Caution when applying Gripper





Forces and Moment : Max allowable forces and moments on jaws.

Product Name	Fa (N)	Mp (Nm)	My (Nm)	Mr (Nm)	Page
AF28D-30	81	17.0	10.2	6.4	98
AF30-20	85	28.3	17.0	17.0	106
AF30-25	137	38.0	22.8	21.4	106
AF30-30	198	42.9	25.7	24.8	106
AF30-40	350	58.3	35.0	35.0	106
AF30-50	548	71.9	43.1	43.8	106
AF30-63	863	89.9	54.0	54.0	106
AF30-90	1452	121.0	72.6	68.5	106
AF30-125	2898	201.3	120.8	96.6	106
AF30SP-30	237	44.0	26.4	29.7	116
AF30SP-40	406	56.4	33.8	40.6	116
AF30SP-50	614	73.1	43.9	49.1	116
AF30DP-25	159	66.2	39.7	21.8	122
AF30DP-30	279	77.5	46.5	31.7	122
AF30DP-40	479	99.8	59.9	44.4	122
AF30DP-50	706	117.7	70.6	51.2	122
AF26-16	37	20.7	12.4	9.3	128
AF26-20	59	24.5	14.7	11.8	128
AF26-25	100	33.2	19.9	16.6	128
AF26-30	124	37.6	22.6	19.1	128

Gripper

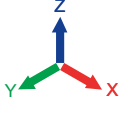
Caution when applying Gripper





Forces and Moment : Max allowable forces and moments on jaws.

					
Product Name	Fa (N)	Mp (Nm)	My (Nm)	Mr (Nm)	Page
AF26-40	256	60.8	36.5	26.9	128
AF26-50	369	76.9	46.2	35.2	128
AF26-63	507	84.4	50.7	40.5	128
AF26-80	883	113.2	67.9	63.1	128
AF26-100	1050	116.5	69.9	64.7	128
AF46-30	350	116.7	70.0	70.0	138
AF46-40	650	180.6	108.3	101.6	138
AF46-55	1400	291.7	175.0	175.0	138
AF46-75	2500	416.7	230.0	230.0	138
AF46-95	3000	430.0	250.0	250.0	138
AF46-125	4000	450.0	280.0	280.0	138
AF46-160N	7000	583.3	350.0	350.0	138
AF46DP-40	600	142.9	85.7	72.3	148
AF46DP-55	1200	250	150	130.4	148
AF46DP-75	2500	416.7	250	208.3	148
AF56N-20B	91	50.7	30.4	22.3	154
AF56N-25B	127	52.9	31.8	24.4	154
AF56N-30B	219	73.1	43.9	36.5	154
AF56N-40B	402	111.7	67.0	55.9	154
AF56N-50B	532	120.0	70	64.1	154

Gripper

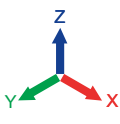
Caution when applying Gripper

Forces and Moment : Max allowable forces and moments on jaws.

					
Product Name	Fa (N)	Mp (Nm)	My (Nm)	Mr (Nm)	Page
AF56N-63B	795	132.4	79.5	77.9	154
AF56N-80B	1336	185.5	111.3	102.7	154
AF56N-100B	1781	212.0	127.2	116.4	154
AF03-20	18	3.4	2.0	4.5	164
AF03-30	52	8.7	5.2	10.5	164
AF03-40	93	12.9	7.8	15.5	164
AF06-30	38	12.6	7.6	7.6	170
AF06-40	50	13,8	8.1	8.3	170
AF17-25	95	3.2	1.9	1.8	176
AF17-40	230	7.7	4.6	3.5	176
AF117-16	190	10.6	6.3	3.2	182
AF117-20	260	10.8	6.5	8.1	182
AF117-25	300	11.0	6.6	7.5	182
AF117-30	400	11.1	6.7	9.1	182
AF117-40	700	16.7	10.0	12.1	182
AF117-50	1500	33.3	20.0	22.1	182
AF117-63	3200	42.7	25.6	32.0	182
AF117-80	6300	70.0	42.0	50.8	182
AF19-10	9	4.9	2.9	0.6	192
AF24-12N	10	3.6	2.2	3.8	196

Gripper

Caution when applying Gripper

Forces and Moment : Max allowable forces and moments on jaws.

Product Name	Fa (N)	Mp (Nm)	My (Nm)	Mr (Nm)	Page
AF24-16N	15	4.1	2.5	4.9	196
AF24-20	24	5.6	3.4	6.5	196
AF24-30	61	11.9	7.2	13.2	196
AF24-40	96	13.3	8.0	16.5	196
AF40-40	800	130	80	100	204
RAF56N-32	220	70	45	35	210
RAF56N-40	400	110	65	55	210
RAF56N-50	530	110	65	65	210
RAF56N-63	800	130	80	80	210

Gripper

Caution when applying Gripper

2) The example of gripping force calculation by the type of simple progress

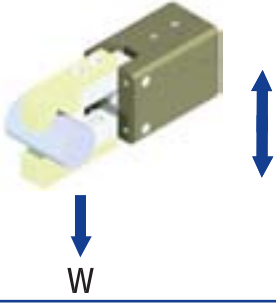
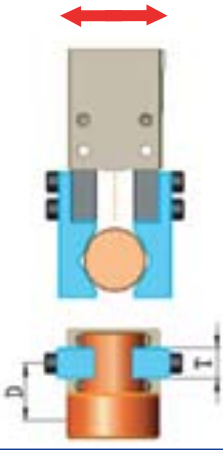
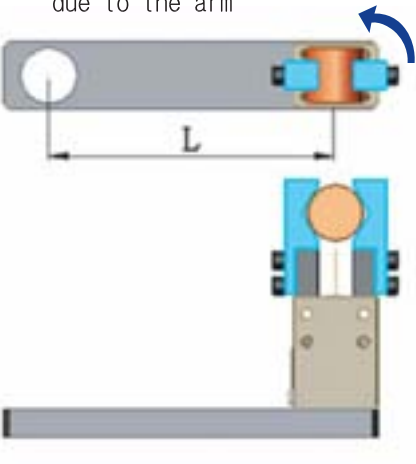
<p>1) Horizontality transfer</p> 	$F_G \geq \frac{W(38.5+a)}{0.85 \times P} \times g$ <p> F_G: Necessary grip force (kg) W: Work weight (kg) a: Transfer acceleration (m/s^2) P: Air pressure (bar) g: Gravity (m/s^2) </p>	<p> $W=0.5$ kg, $a=10$ m/s^2 $P=5$ bar, $g=9.81$ m/s^2 </p> $F_G \geq \frac{0.5(38.5+10)}{0.85 \times 5} \times 9.81$ $= 56.02$ N
<p>2) Perpendicular transfer</p> 	$F_G \geq \left\{ \frac{W(38.5+a)}{9.8} + W \right\} \times \frac{11.52}{P} \times g$	<p> $W=0.5$ kg, $a=10$ m/s^2 $P=5$ bar, $g=9.81$ m/s^2 </p> $F_G \geq \left\{ \frac{0.5(38.5+10)}{9.8} + 0.5 \right\}$ $\times \frac{11.52}{5} \times 9.81 = 78.58$ N
<p>3) The horizontality transfer which is the side load</p> 	$F_G \geq \left\{ W + \frac{2 \times A \times D}{T} \right\} \times \left(\frac{38.5+a}{0.85 \times P} \right) \times g$ <p> A: Side load (kg) D: From grip force distance until in side load center T: Jaw contact surface length </p>	<p> $W=0.5$ kg, $a=10$ m/s^2 $A=0.2$ kg, $D=30$ mm $T=20$ mm, $P=5$ bar $g=9.81$ m/s^2 </p> $F_G \geq \left\{ 0.5 + \frac{2 \times 0.2 \times 30}{20} \right\}$ $\times \left(\frac{38.5+10}{0.85 \times 5} \right) \times 9.81$ $= 123.12$ N
<p>4) the rotation transfer due to the arm</p> 	$F_G \geq \frac{W(38.5+L \times \alpha)}{0.85 \times P} \times g$ <p> L: From the arm of rotary point the distance until in tip work center α: Angular acceleration ($1/s^2$) </p>	<p> $\Theta=180^\circ = 1.57$ rad = $\pi / 2$ $t=0.5$ sec, $L=200$ mm $P=5$ bar, $W=0.5$ kg $g=9.81$ m/s^2 $\alpha = (1.57)^2 / s^2$ </p> $F_G \geq \frac{0.5(38.5+200 \times (\frac{1.57}{1.5}))}{0.85 \times 5} \times 9.81$ $= 297.15$ N

Gripper

Caution when applying Gripper

3) Attachment Design

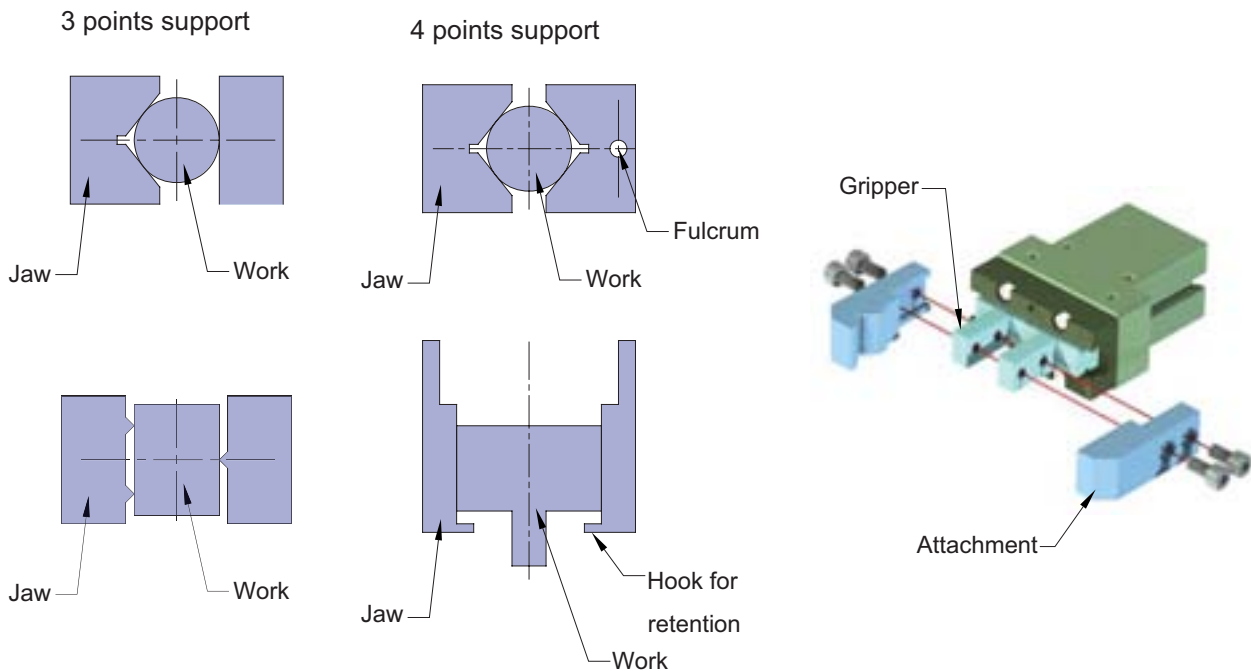

4) Relation of the Gripping Force and Weight of the Work

4-1) Weight of the work, Which is able to grasp by the gripping, is generally less than 1/10 of the Gripping force. This value is considered to be necessary to avoid declining or falling of the work from the gripper on the way of transportation and change extremely by the following factors.

4-1-1) Coefficient of the friction between the jaw and the work

4-1-2) Shock at stopping (Resistance of inertia caused by deceleration) on the transportation of the work

4-1-3) Direction of the transportation (horizontal, vertical or oblique)

4-1-4) Relation between direction of the grasp and that of the movement

4-1-5) The center of gravity of the work, the shape of the jaw and the relation of their position.

4-1-6) Volume of the work

Gripper

Caution when applying Gripper

4-2) Weight of the work

4-2-1) 2 Finger Parallel Grippers

-The supplied air pressure of the gripping force calculated is 6bar and maximum exertion length

Products name	Gripping force 1 / 20 (Kg)	Gripping force 1 / 10 (Kg)	Gripping force 1 / 5 (Kg)	Max Jaw length (mm)
AF101-10N	0.12	0.24	0.48	20
AF101-12	0.16	0.32	0.65	30
AF02-16	0.27	0.54	1.07	50
AF02-20	0.43	0.87	1.74	90
AF02-30	1.20	2.40	4.80	100
AF02-40	3.43	6.86	13.73	160
AF02-63	6.47	12.94	25.89	200
AF04P-12N	0.13	0.27	0.53	20
AF04P-16	0.20	0.40	0.79	30
AF04P-20	0.30	0.60	1.20	40
AF105P-08	0.10	0.20	0.39	25
AF105P-10	0.15	0.31	0.61	30
AF105P-16	0.34	0.68	1.35	40
AF10-20	0.18	0.37	0.74	60
AF10-30	0.34	0.67	1.35	85
AF10-40	0.45	0.90	1.80	120
AF10-50	0.57	1.15	2.29	160
AF13-20	0.22	0.44	0.87	70
AF13-30	0.53	1.05	2.10	90
AF13-40	0.80	1.59	3.19	110
AF13-50	1.42	2.85	5.69	130
AF13-63	2.69	5.38	10.75	140
AF13-80	4.28	8.57	17.14	150
AF13-100	6.07	12.14	24.28	200
AF13C-20	0.22	0.44	0.87	70
AF13C-30	0.53	1.05	2.10	90
AF13C-40	0.80	1.59	3.19	110
AF13C-50	1.42	2.85	5.69	130
AF14-20	1.05	2.11	4.22	70
AF14-30	1.81	3.62	7.24	80
AF15-12	0.13	0.26	0.51	60
AF15-16	0.23	0.46	0.92	70
AF15-20	0.45	0.90	1.81	90
AF316-16	0.21	0.42	0.85	50
AF316-20	0.65	1.29	2.58	65
AF316-25	0.98	1.96	3.93	80
AF28D-10	0.05	0.10	0.20	20
AF28D-14	0.10	0.20	0.40	30
AF28D-16	0.12	0.24	0.49	40
AF28D-20	0.17	0.35	0.69	60
AF28D-30	0.42	0.83	1.66	80

Gripper

Caution when applying Gripper

-The supplied air pressure of the gripping force calculated is 6bar and maximum exertion length

Products name	Gripping force 1 / 20 (Kg)	Gripping force 1 / 10 (Kg)	Gripping force 1 / 5 (Kg)	Max Jaw length(mm)
AF30-20	0.43	0.87	1.73	50
AF30-25	0.70	1.40	2.79	60
AF30-30	1.01	2.02	4.04	77
AF30-40	1.78	3.56	7.13	100
AF30-50	2.79	5.58	11.17	127
AF30-63	4.40	8.80	17.60	160
AF30-90	7.40	14.80	29.60	200
AF30-125	14.77	29.55	59.09	240
AF30SP-30	1.21	2.42	4.84	90
AF30SP-40	2.07	4.14	8.28	120
AF30SP-50	3.13	6.26	12.52	140
AF30DP-25	0.81	1.62	3.24	40
AF30DP-30	1.42	2.84	5.69	60
AF30DP-40	2.44	4.88	9.77	80
AF30DP-50	3.60	7.20	14.40	100

4-2-2) Centric Grippers

Products name	Gripping force 1 / 20 (Kg)	Gripping force 1 / 10 (Kg)	Gripping force 1 / 5 (Kg)	Max Jaw length(mm)
AF26-16	0.19	0.38	0.76	30
AF26-20	0.30	0.60	1.20	40
AF26-25	0.51	1.01	2.03	50
AF26-30	0.63	1.26	2.53	55
AF26-40	1.30	2.60	5.21	70
AF26-50	1.88	3.76	7.53	80
AF26-63	2.58	5.17	10.33	100
AF26-80	4.50	9.00	18.00	130
AF26-100	5.35	10.69	21.38	150
AF46-30	1.08	2.16	4.32	50
AF46-40	2.03	4.05	8.11	60
AF46-55	3.97	7.93	15.87	80
AF46-75	7.25	14.51	29.01	100
AF46-95	7.50	15.00	30.00	120
AF46-125	7.27	14.54	29.08	160
AF46-160N	21.75	43.50	87.00	200
AF46DP-40	1.75	3.50	6.99	70
AF46DP-55	3.02	6.03	12.06	80
AF46DP-75	6.46	12.92	25.83	100
AF56N-20	0.47	0.93	1.86	30
AF56N-25	0.65	1.30	2.59	40
AF56N-32	1.12	2.23	4.47	50
AF56N-40	2.05	4.10	8.20	60
AF56N-50	2.71	5.42	10.85	80
AF56N-63	4.05	8.10	16.20	100
AF56N-80	6.81	13.61	27.23	120
AF56N-100	9.08	18.15	36.31	140

Gripper

Caution when applying Gripper

4-2-3) Angular Grippers

The supplied air pressure of the gripping force calculated is 6bar and maximum exertion length

Products name	Gripping force 1 / 20 (Kg)	Gripping force 1 / 10 (Kg)	Gripping force 1 / 5 (Kg)	Max Jaw length(mm)
AF03-20	0.09	0.19	0.37	90
AF03-30	0.27	0.53	1.07	100
AF03-40	0.48	0.95	1.90	120
AF06-30	0.19	0.39	0.77	50
AF06-40	0.25	0.50	1.01	70
AF17-25	0.10	0.19	0.38	50
AF17-40	0.23	0.47	0.94	50
AF117-16	0.32	0.64	1.27	30
AF117-20	0.33	0.67	1.34	40
AF117-30	0.31	0.62	1.24	50
AF117-40	0.29	0.57	1.14	60
AF117-50	0.51	1.02	2.04	70
AF117-63	1.03	2.06	4.13	75
AF117-80	1.33	2.66	5.33	125
AF117-100	2.16	4.32	8.64	150
AF19-10	0.05	0.09	0.18	30
AF24-12N	0.05	0.10	0.20	45
AF24-16N	0.08	0.15	0.30	60
AF24-20	0.12	0.24	0.48	70
AF24-30	0.31	0.62	1.24	85
AF24-40	0.49	0.98	1.95	120

4-2-4) Air Chuck

Products name	Gripping force 1 / 20 (Kg)	Gripping force 1 / 10 (Kg)	Gripping force 1 / 5 (Kg)	Max Jaw length(mm)
AF40-40	4.10	8.20	16.40	100

4-2-5) Grip & Rotate

Products name	Gripping force 1 / 20 (Kg)	Gripping force 1 / 10 (Kg)	Gripping force 1 / 5 (Kg)	Max Jaw length(mm)
RAF56N-32	1.12	2.23	4.47	50
RAF56N-40	2.05	4.10	8.20	60
RAF56N-50	2.71	5.42	10.85	80
RAF56N-63	4.05	8.10	16.20	100

4-2-6) Mechanical Gripper

Products name	Gripping force 1 / 20 (Kg)	Gripping force 1 / 10 (Kg)	Gripping force 1 / 5 (Kg)	Max Jaw length(mm)
MF16-S	0.08	0.15	0.31	32
MF16-M	0.11	0.23	0.46	40
MF16-L	0.17	0.33	0.66	60

Gripper

The gripping force is the value at the air pressure of 6 [bar] and maximum exertion length

2 Finger Parallel Grippers

AF101 Rack & Pinion Type

Type	Stroke (mm)	Gripping Force (N)		Max Jaw Length (mm)	Weight (kg)	Page
		Open	Close			
10(A,B)	6	37.4	23.4	20	0.14	30
10N(A,B)	6	37.4	23.4	20	0.14	
12(A,B)	20	58.9	31.7	30	0.29	



AF02 Rack & Pinion Type

Type	Stroke (mm)	Gripping Force (N)		Max Jaw Length (mm)	Weight (kg)	Page
		Open	Close			
16(A,B)	30	89.9	52.7	50	0.55	36
20(A,B)	40	85.2	85.2	90	1.06	
30(A,B)	60	235.4	235.4	100	2.91	
40(A,B)	100	673.3	673.3	160	5.90	
63(A,B)	130	1269.7	1269.7	200	17.76	

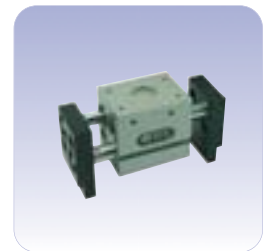

AF04P Link Lever Type

Type	Stroke (mm)	Gripping Force (N)		Max Jaw Length (mm)	Weight (kg)	Page
		Open	Close			
12N	5	30.0	26.0	20	0.08	46
16	5	34.8	38.8	30	0.15	
20	8	78.5	58.9	40	0.20	

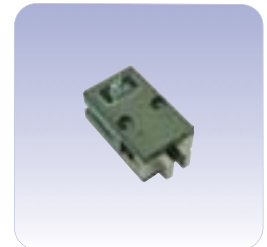

AF105P Roller Guide Type

Type	Stroke (mm)	Gripping Force (N)		Max Jaw Length (mm)	Weight (kg)	Page
		Open	Close			
08	4	13.8	19.3	25	0.06	52
10	5	18.5	29.9	30	0.11	
16	8	53.0	66.2	40	0.27	



AF10 Rack & Pinion Type

Type	Stroke (mm)	Gripping Force (N)		Max Jaw Length (mm)	Weight (kg)	Page
		Open	Close			
20	30	36.2		60	0.71	58
30	40	66.0		85	2.00	
40	60	88.3		120	4.60	
50	100	112.5		160	9.22	

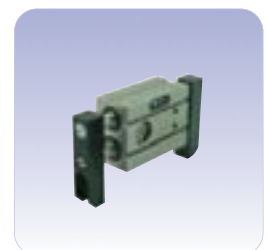

Gripper

The gripping force is the value at the air pressure of 6 [bar] and maximum exertion length

2 Finger Parallel Grippers

AF13 Rack & Pinion Type

Type	Stroke (mm)	Gripping Force (N)		Max Jaw Length (mm)	Weight (kg)	Page
		Open	Close			
20	12	53.5	42.8	70	0.55	64
30	24	119.8	103.0	90	1.30	
40	30	183.9	156.3	110	2.20	
50	36	313.3	279.3	130	3.33	
63	40	605.8	527.3	140	5.03	
80	50	948.8	840.5	150	8.12	
100	60	1308.7	1190.9	200	12.21	



AF13C Rack & Pinion Type

Type	Stroke (mm)	Gripping Force (N)		Max Jaw Length (mm)	Weight (kg)	Page
		Open	Close			
20	12	53.5	42.8	70	0.55	74
30	24	119.8	103.0	90	1.42	
40	30	183.9	156.3	110	2.20	
50	36	313.3	279.3	130	3.70	



AF14 Taper Roller Guide Type

Type	Stroke (mm)	Gripping Force (N)		Max Jaw Length (mm)	Weight (kg)	Page
		Open	Close			
20	10	143.7	207.0	70	0.38	80
30	12	258.7	356.4	80	0.72	



AF15 Rack & Pinion Type

Type	Stroke (mm)	Gripping Force (N)		Max Jaw Length (mm)	Weight (kg)	Page
		Open	Close			
12	20	25.1		60	0.42	86
16	30	40.5		70	0.81	
20	36	77.2		90	1.60	

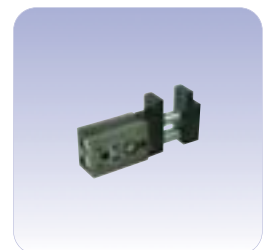

AF316 Cross Roller Guide Type

Type	Stroke (mm)	Gripping Force (N)		Max Jaw Length (mm)	Weight (kg)	Page
		Open	Close			
16	8	66.8	41.5	50	0.21	92
20	10	128.4	126.6	65	0.28	
25	14	204.6	192.7	80	0.65	



Gripper

The gripping force is the value at the air pressure of 6 [bar] and maximum exertion length

2 Finger Parallel Grippers

AF28D Link Lever Type

Type	Stroke (mm)	Gripping Force (N)		Jaw Length (mm)	Weight (kg)	Page
		Open	Close			
10	15	9.6		20	0.13	98
14	20	19.8		30	0.30	
16	24	23.9		40	0.42	
20	30	33.9		60	0.80	
30	36	81.6		80	1.57	



AF30 Wedge Type

Type	Stroke (mm)	Gripping Force (N)		Jaw Length (mm)	Weight (kg)	Page
		Open	Close			
20	8	94.8	85.0	50	0.14	106
25	12	150.6	136.9	60	0.30	
30	16	222.5	198.2	77	0.47	
40	20	398.2	349.7	100	0.81	
50	26	611.3	547.8	127	1.37	
63	32	961.4	863.3	160	2.60	
90	50	1550.0	1451.9	200	4.78	
125	60	2960.1	2898.5	240	13.90	



AF30SP Special Wedge Type

Type	Stroke (mm)	Gripping Force (N)		Jaw Length (mm)	Weight (kg)	Page
		Open	Close			
30	16	282.9	237.4	90	0.55	116
40	20	463.8	406.3	120	0.87	
50	26	707.0	614.2	140	1.48	



AF30DP Dust Proof Type

Type	Stroke (mm)	Gripping Force (N)		Jaw Length (mm)	Weight (kg)	Page
		Open	Close			
25	12	175.0	159.1	40	0.40	122
30	16	332.5	279.0	60	0.72	
40	20	547.1	479.1	80	1.28	
50	26	813.0	706.3	100	1.48	



Gripper

The gripping force is the value at the air pressure of 6 [bar] and maximum exertion length

Centric Grippers

AF26 Link Lever Type

Type	Stroke (mm)	Gripping Force (N)		Max Jaw Length (mm)	Weight (kg)	Page
		Open	Close			
16	6	48.2	37.5	30	0.21	128
20	8	73.6	58.9	40	0.32	
25	12	123.0	99.4	50	0.51	
30	12	168.5	123.9	55	0.63	
40	20	338.8	255.5	70	1.59	
50	20	446.8	369.2	80	2.12	
63	26	598.8	506.7	100	3.44	
80	30	1003.2	882.9	130	5.02	
100	42	1527.7	1048.8	150	7.83	



AF46 Wedge Type

Type	Stroke (mm)	Gripping Force (N)		Max Jaw Length (mm)	Weight (kg)	Page
		Open	Close			
30	8	243.3	211.9	50	0.24	138
40	12	445.4	397.9	60	0.43	
55	16	804.4	778.3	80	0.75	
75	20	1488.8	1423.0	100	1.30	
95	26	1531.6	1471.5	120	2.05	
125	32	1516.8	1426.2	160	4.07	
160N	50	4561.7	4267.4	200	10.85	

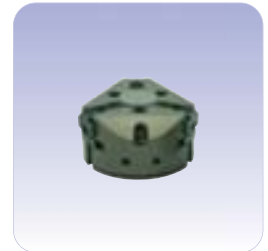

AF46DP Dust Proof Type

Type	Stroke (mm)	Gripping Force (N)		Max Jaw Length (mm)	Weight (kg)	Page
		Open	Close			
40	12	375.5	343.0	70	0.72	148
50	16	618.6	591.6	80	1.19	
75	20	1316.6	1267.0	100	2.41	



Gripper

The gripping force is the value at the air pressure of 6 [bar] and maximum exertion length

Centric Grippers

Type	Stroke (mm)	Gripping Force (N)		Max Jaw Length (mm)	Weight (kg)	Page
		Open	Close			
20	5	103.4	91.5	30	0.15	154
25	6	151.1	127.3	40	0.23	
32	8	235.4	219.2	50	0.26	
40	10	439.4	402.1	60	0.44	
50	12	577.3	532.0	80	0.72	
63	16	893.9	794.6	100	1.20	
80	20	1515.6	1335.4	120	2.10	
100	23	1992.2	1780.9	140	3.40	



Gripper

The gripping force is the value at the air pressure of 6 [bar] and maximum exertion length

Angular Grippers

AF03 Link Lever Type

Type	Opening angle	Gripping Force (N)		Max Jaw Length (mm)	Weight (kg)	Page
		Open	Close			
20	-4 to 19°	24.9	18.3	90	0.19	164
30	-5 to 20°	65.9	52.4	100	0.41	
40	-5 to 25°	116.7	93.2	120	0.79	



AF06 Link Lever Type

Type	Opening angle	Gripping Force (N)		Max Jaw Length (mm)	Weight (kg)	Page
		Open	Close			
30	-5 to 20°	60.6	37.9	50	0.39	170
40	-5 to 20°	85.2	49.3	70	0.64	



AF17 Rack & Pinion Type

Type	Opening angle	Gripping Force (N)		Max Jaw Length (mm)	Weight (kg)	Page
		Open	Close			
25	0 to 180°	27.1	18.8	50	0.80	176
40	0 to 180°	61.2	45.9	50	0.86	

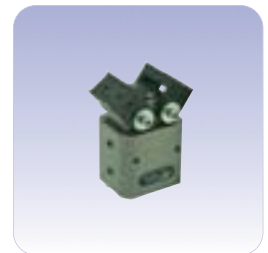

AF117 Crank Lever Type

Type	Opening angle	Gripping Force (N)		Max Jaw Length (mm)	Weight (kg)	Page
		Open	Close			
16	0 to 180°	69.0	62.5	30	0.21	182
20	0 to 180°	70.1	65.7	40	0.27	
25	0 to 180°	67.1	60.9	50	0.38	
30	0 to 180°	63.8	55.9	60	0.69	
40	0 to 180°	116.9	100.1	70	1.20	
50	0 to 180°	246.4	202.5	75	2.10	
63	0 to 180°	291.5	261.3	125	3.50	
80	0 to 180°	470.9	423.8	150	4.70	

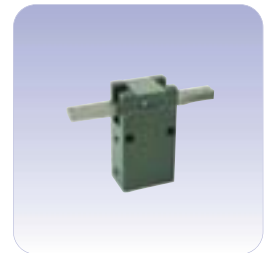

Gripper

The gripping force is the value at the air pressure of 6 [bar] and maximum exertion length

Angular Grippers

AF19 Cam Roller Type

Type	Opening angle	Gripping Force (N)		Max Jaw Length (mm)	Weight (kg)	Page
		Open	Close			
10	-7 to 14°		8.8	30	0.04	192



AF24 Link Lever Type

Type	Opening angle	Gripping Force (N)		Max Jaw Length (mm)	Weight (kg)	Page
		Open	Close			
12N	-5 to 15°	13.1	9.8	45	0.05	196
16N	-5 to 15°	19.6	14.7	60	0.06	
20	-5 to 20°	31.1	23.5	70	0.20	
30	-5 to 20°	78.2	60.9	85	0.41	
40	-5 to 25°	117.2	95.6	120	0.76	



Gripper

The gripping force is the value at the air pressure of 6 [bar] and maximum exertion length

Air Chuck

AF40 Wedge Guide Type

Type	Stroke (mm)	Gripping Force (N)		Max Jaw Length (mm)	Weight (kg)	Page
		Open	Close			
40	22	1471.5	804.4	100	4.50	204

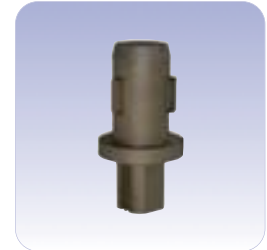

Grip & Rotate

RAF56N Wedge Guide Type

Type	Stroke (mm)	Gripping Force (N)		Max Jaw Length (mm)	Weight (kg)	Page
		Open	Close			
32	8	235.4	219.2	50	0.95	210
40	10	439.4	402.1	60	1.43	
50	12	577.3	532.0	80	1.74	
63	16	893.9	794.6	100	2.40	



Mechanical Gripper

MF16 Mechanical Type

Type	Stroke (mm)	Gripping Force (N)		Max Jaw Length (mm)	Weight (kg)	Page
		Close				
S	12	10 to 20		3.2	0.20	216
M	14	15 to 30		4	0.34	
L	16	25 to 40		6	0.50	



Grippers

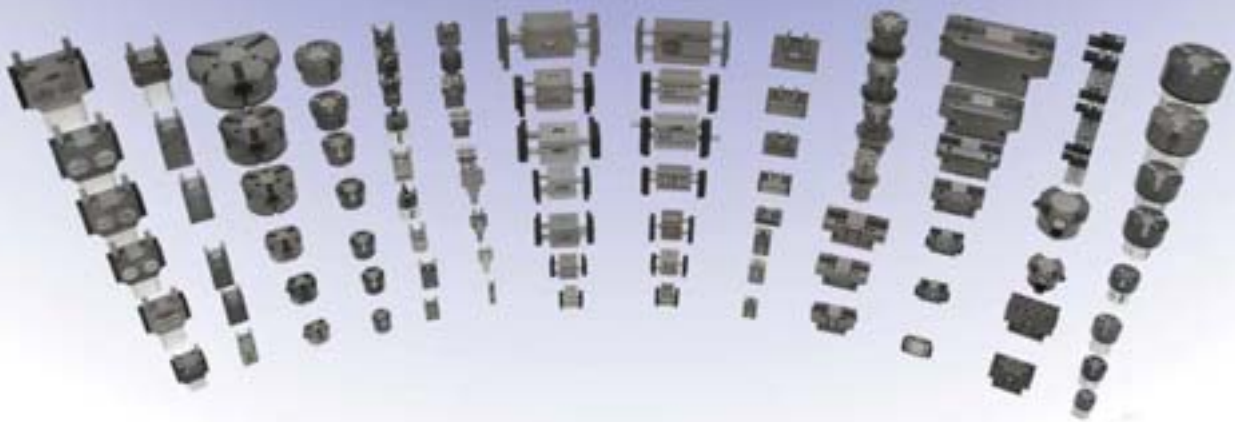

The main function is to grip the object that is waiting for the moving

This pneumatic chuck is similar to the human hands.

The gripper is like the fingers of a man, picking up and placing objects vertically or horizontally.

You can select appropriate products according to the object's weight and shape.

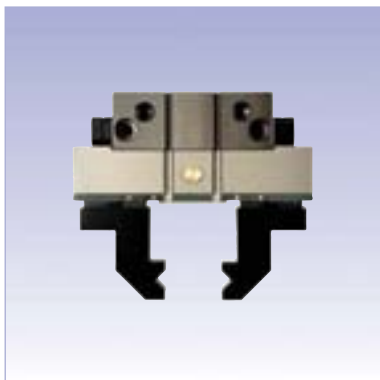

Gripper

AF40-40

Character

- Suitable for inside diameter gripping (Bobbin) by wedge guide driving unit
- Excellent gripping force
- Possible to grip directly without the additional mounting of jaw
- Magnetic sensor is available for open-close sensing



Air chuck suitable for bobbin handling

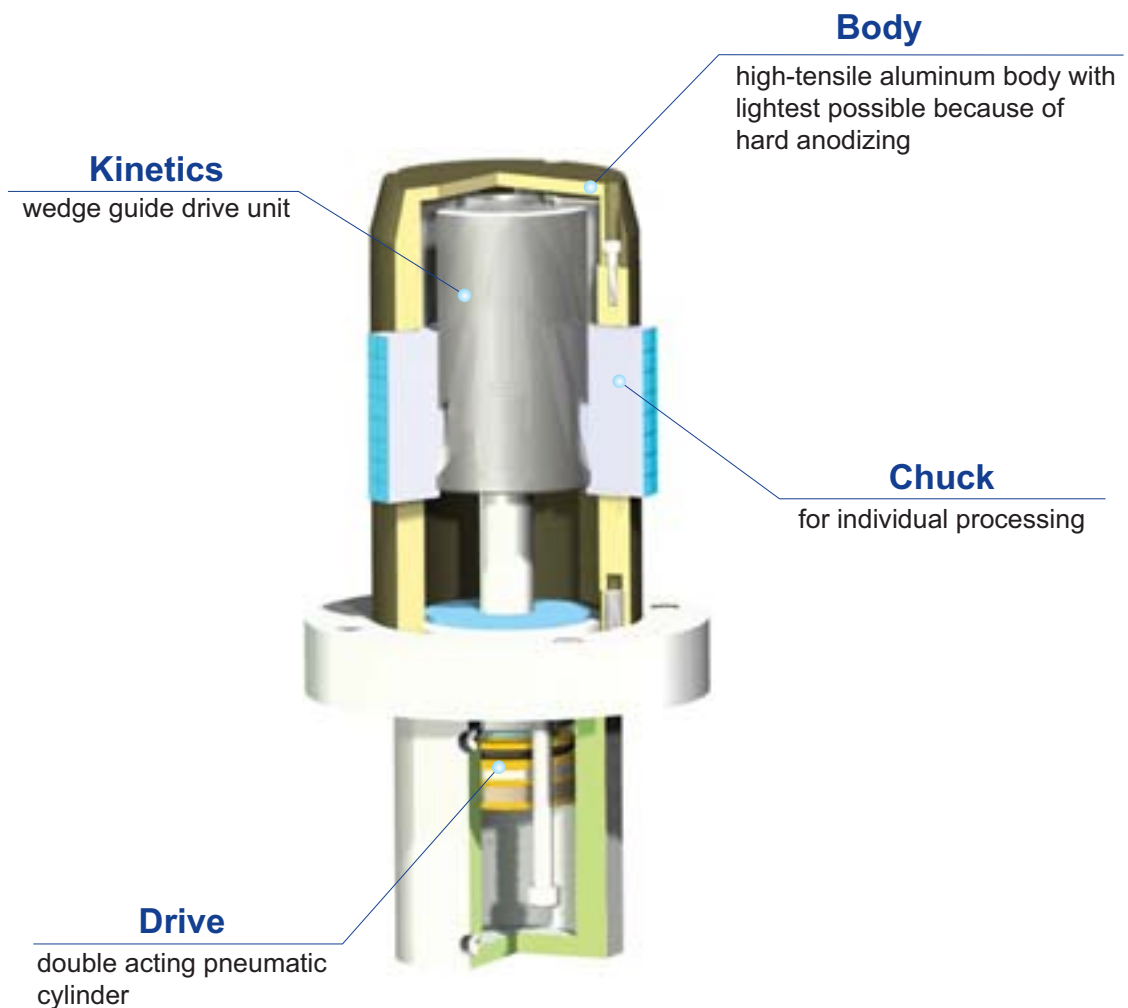

AF40

Exploded view

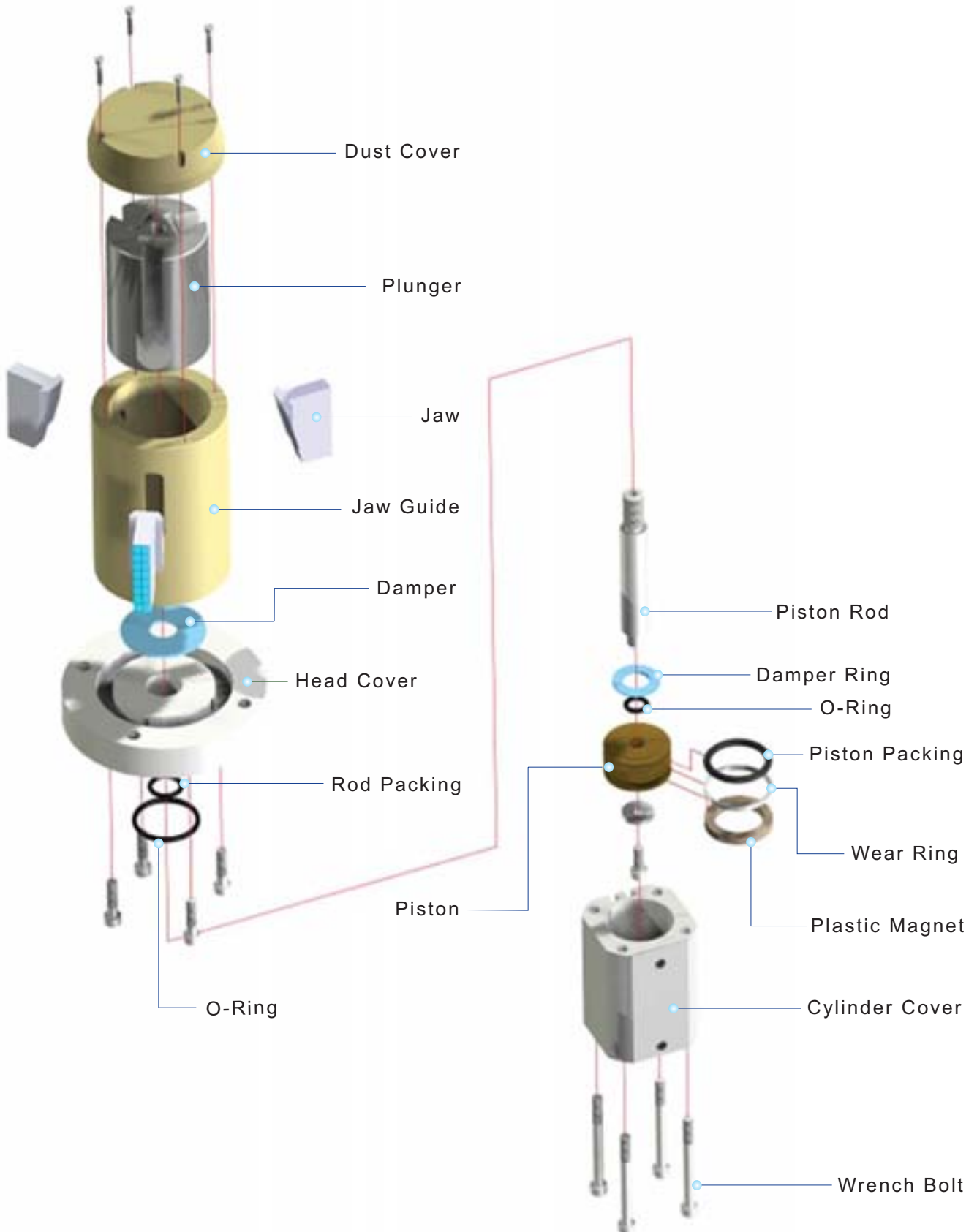

AF40

Ordering Code

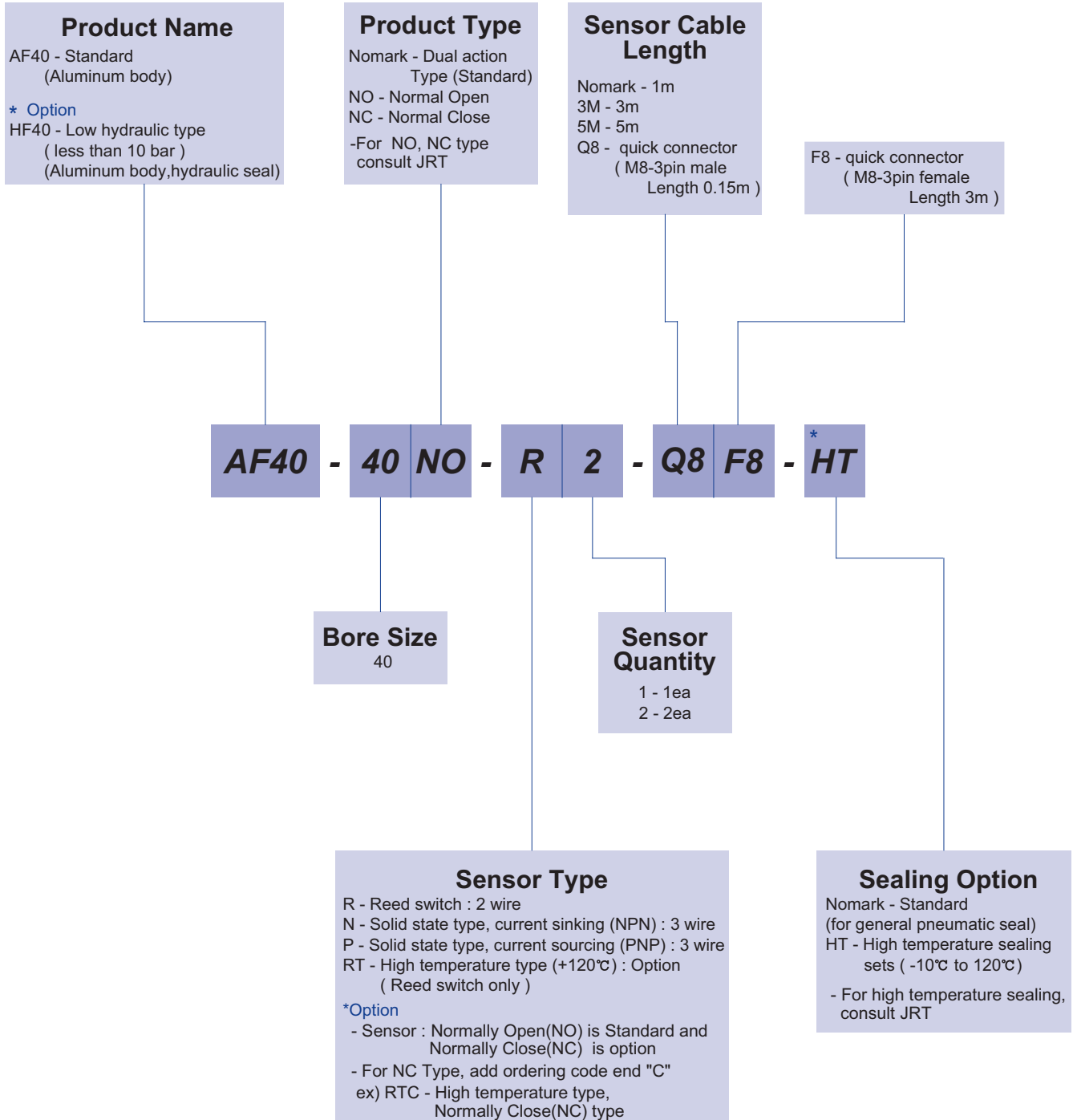

The delivery of * mark option is longer than a standard, So inquire of JRT

AF40

Specification

P=Air Pressure[bar] , L=Exertion length[mm]

Products Name	AF40-40	Unit
Stroke	22	mm
Weight	4.5	kg
Max. length of attach	100	mm
Fitting size	PF(G) 1/8	
Gripping force:Open	$367.88P/(1+0.005L)$	N
Gripping force:Close	$201.11P/(1+0.005L)$	
Air consumption per cycle	92.5	cm ³
Closing / Opening time	0.10 / 0.10	sec
* Repeat accuracy	0.01	mm
Max.cycle per minute	30	
Operating pressure	3~7	bar
Ambient temperature	-5 to 60	°C
Lubrication	Needless	

* After 100 consecutive strokes to end positions

Gripping Force per exertion length

Legend : ■ 7[bar] ■ 5[bar] ■ 3[bar]

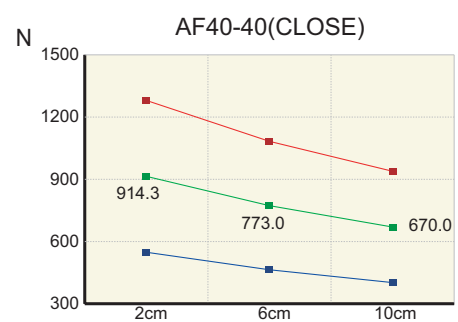
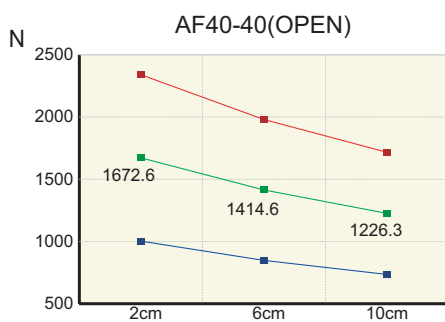

AF40

AF40

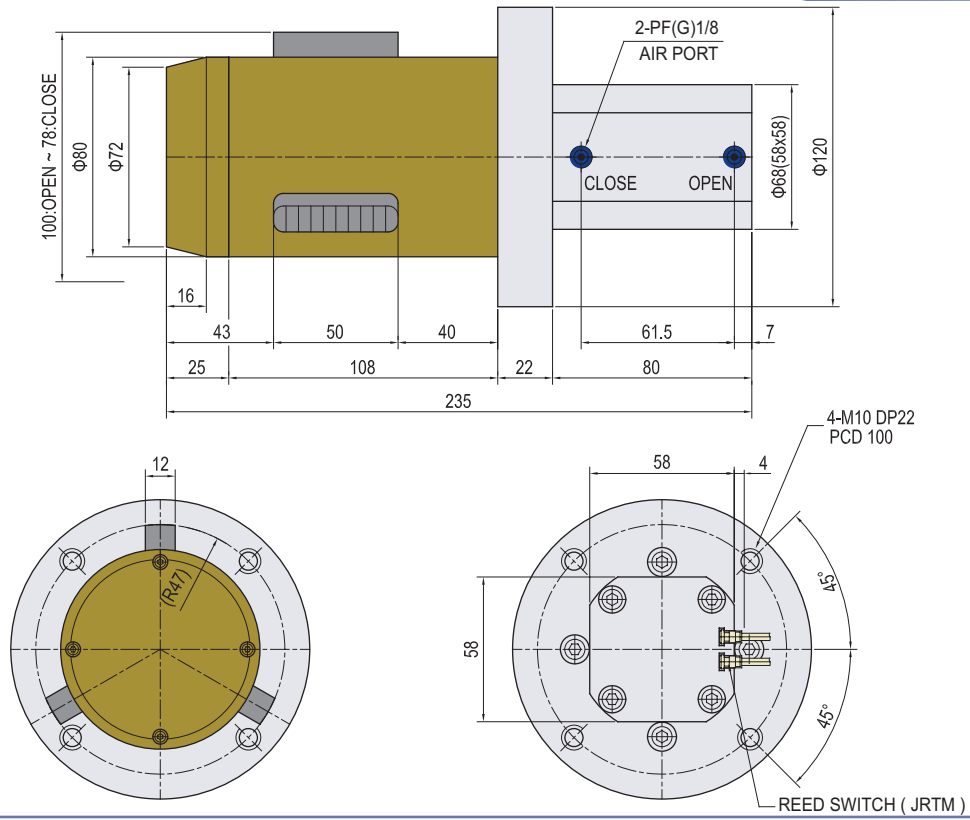

Note

Notes

A large grid of dashed lines for writing notes. The grid consists of 20 columns and 30 rows of squares, with rounded corners on the top and bottom edges. The lines are thin and grey, creating a clean and professional appearance.

Gripper

RAF56N-32,40,50,63

Character

- Compact structure by wedge guide driving unit
- Rotational gripper of AF56N without twist of air supply tube
- Admissible RPM is 100
- Magnetic sensor is available for open-close sensing



Wedge type 3 jaw rotation gripper

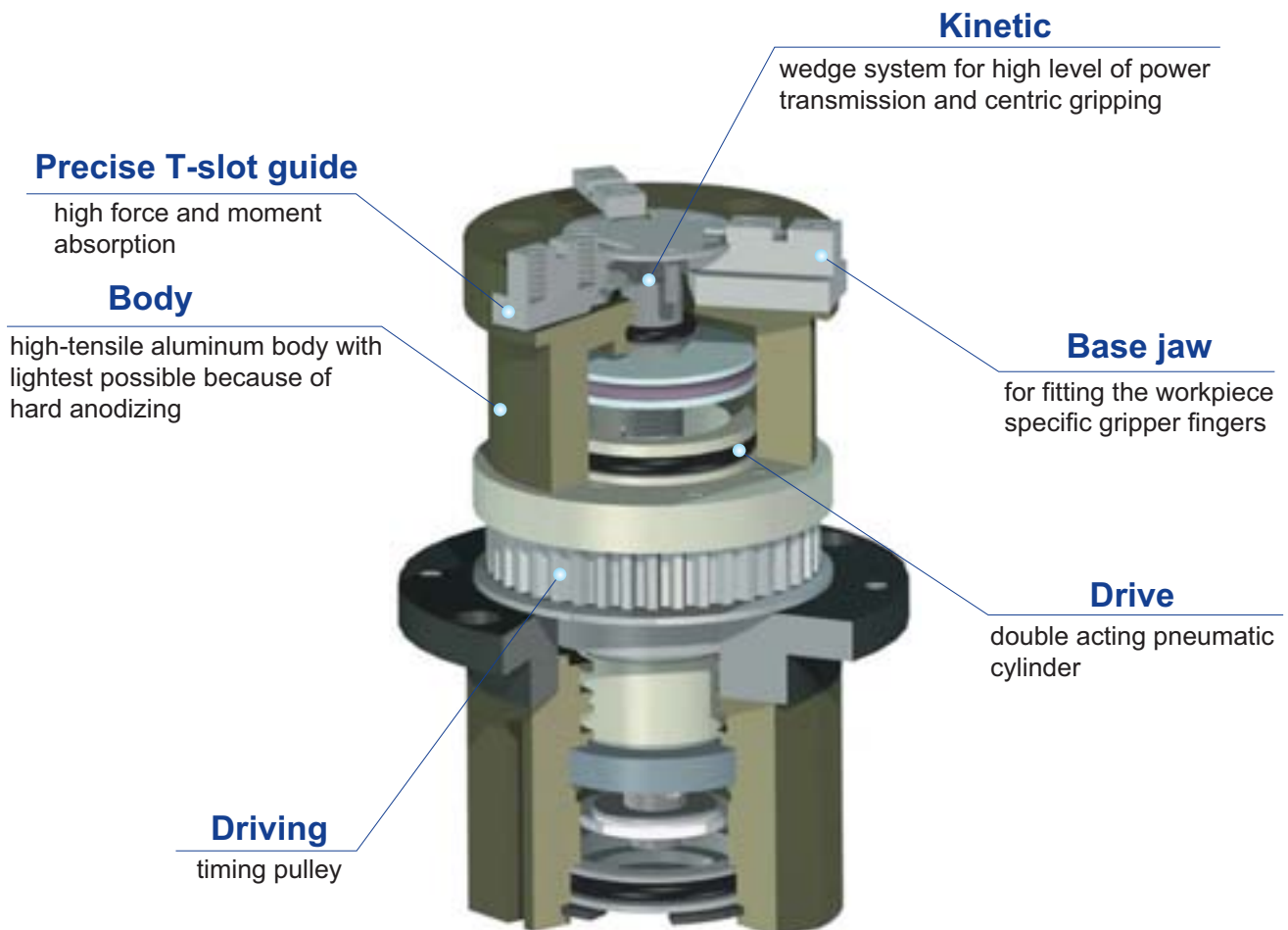

RAF56N

Exploded view

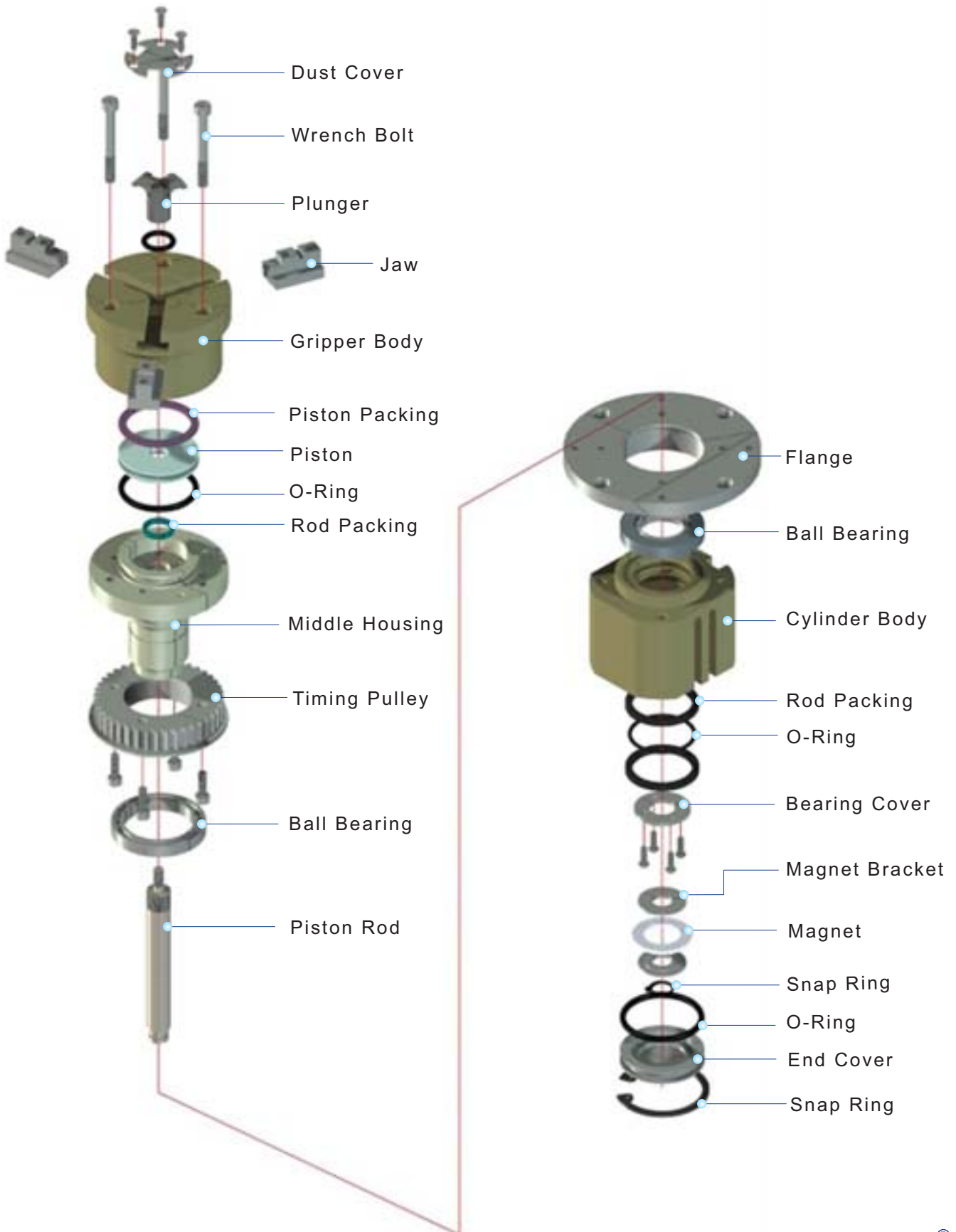

RAF56N

Ordering Code

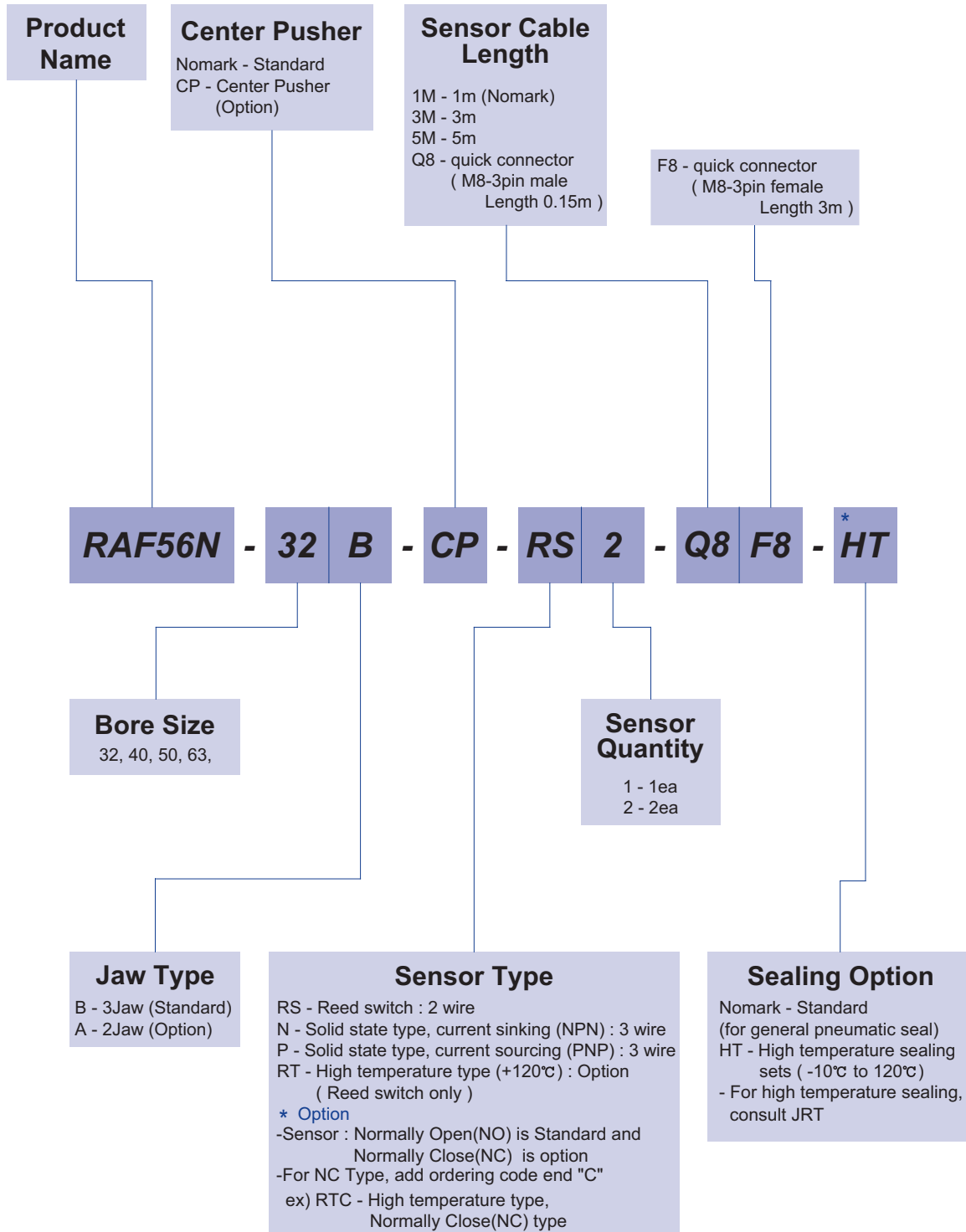

The delivery of * mark option is longer than a standard, So inquire of JRT

RAF56N

Specification

P=Air Pressure[bar] , L=Exertion length[mm]

Products Name	RAF56N-32B	RAF56N-40B	RAF56N-50B	RAF56N-63B	Unit
Stroke	8	10	12	16	mm
Weight	0.95	1.43	1.74	2.40	kg
Max. length of attach	50	60	80	100	mm
Fitting size	M5	M5	M5	M5	
Gripping force:Open	56.90P/(1+0.009L)	103.99P/(1+0.007L)	150.09P/(1+0.007L)	238.38P/(1+0.006L)	N
Gripping force:Close	52.97P/(1+0.009L)	95.16P/(1+0.007L)	138.32P/(1+0.007L)	211.90P/(1+0.006L)	N
Timing pulley spec.	XL037-32NT	XL037-40NT	XL037-40NT	XL037-40NT	
Air consumption per cycle	6.8	14.9	27.9	59.7	cm ³
Closing / Opening time	0.01 / 0.01	0.02 / 0.02	0.03 / 0.03	0.06 / 0.06	sec
* Repeat accuracy	0.01	0.01	0.01	0.01	mm
Max.cycle per minute	60	50	50	50	
Revolution per minute	100				
Operating pressure	3~7				bar
Ambient temperature	-5 to 60				°C
Lubrication	Needless				

* After 100 consecutive strokes to end positions

Note

RAF56N

RAF56N-32B

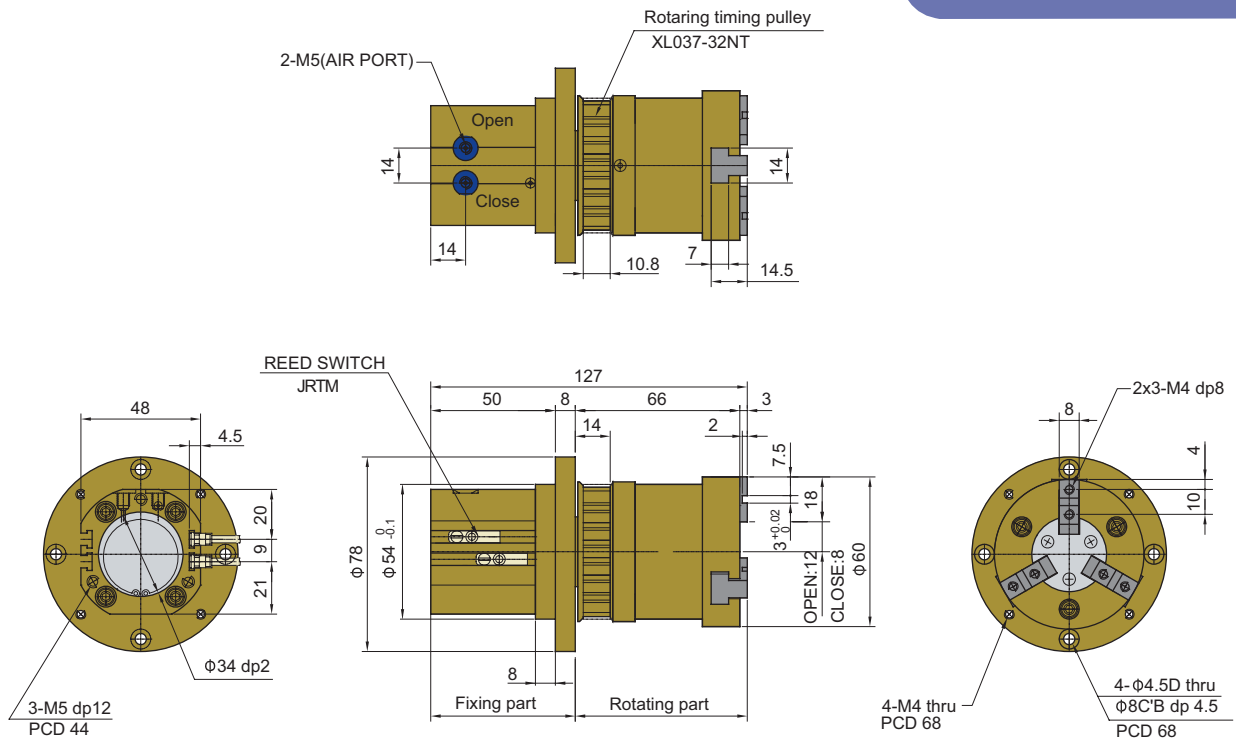

RAF56N-40B

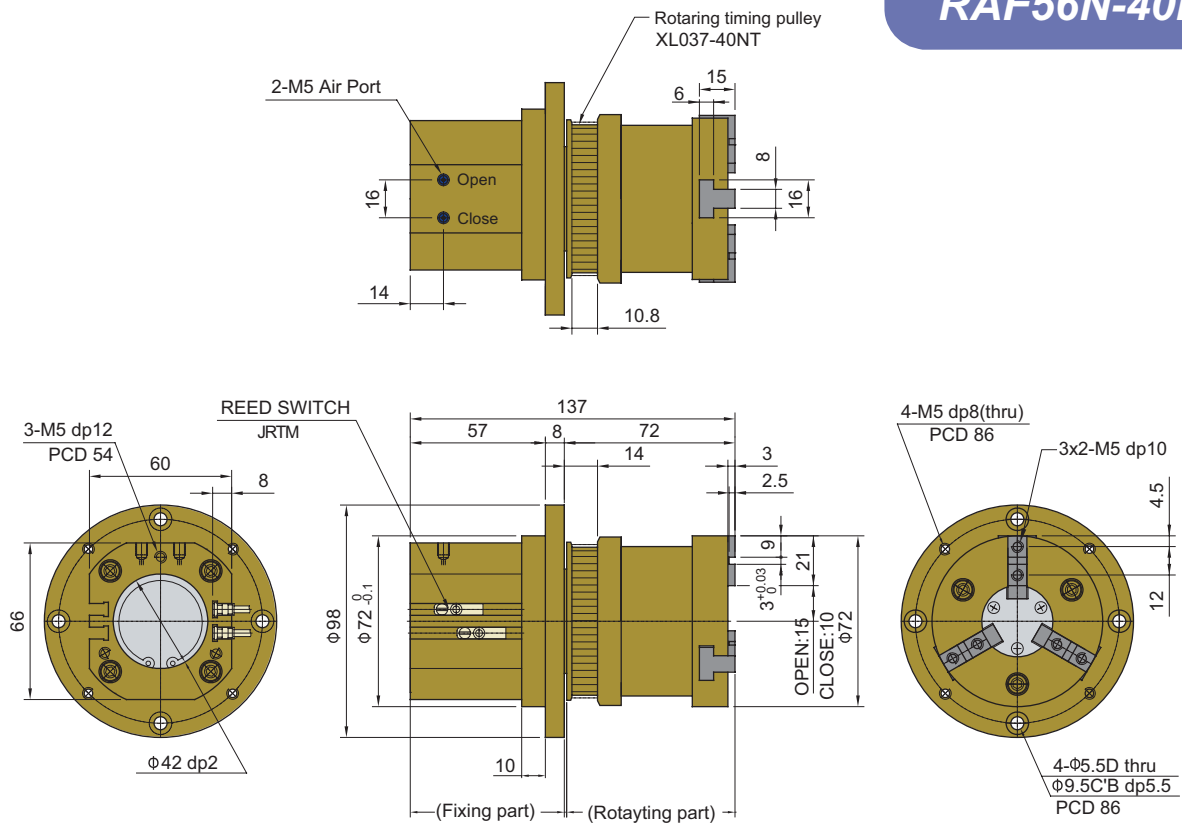

RAF56N

RAF56N-50B

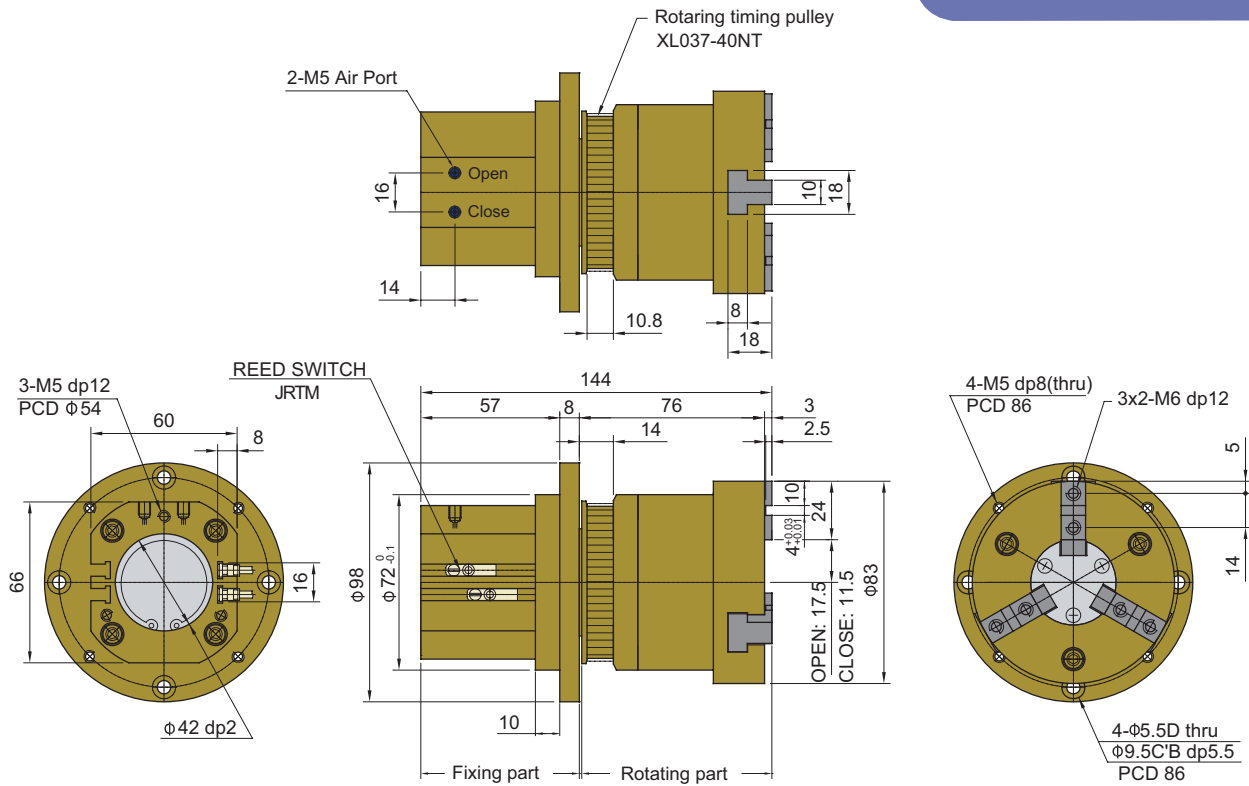

RAF56N-63B

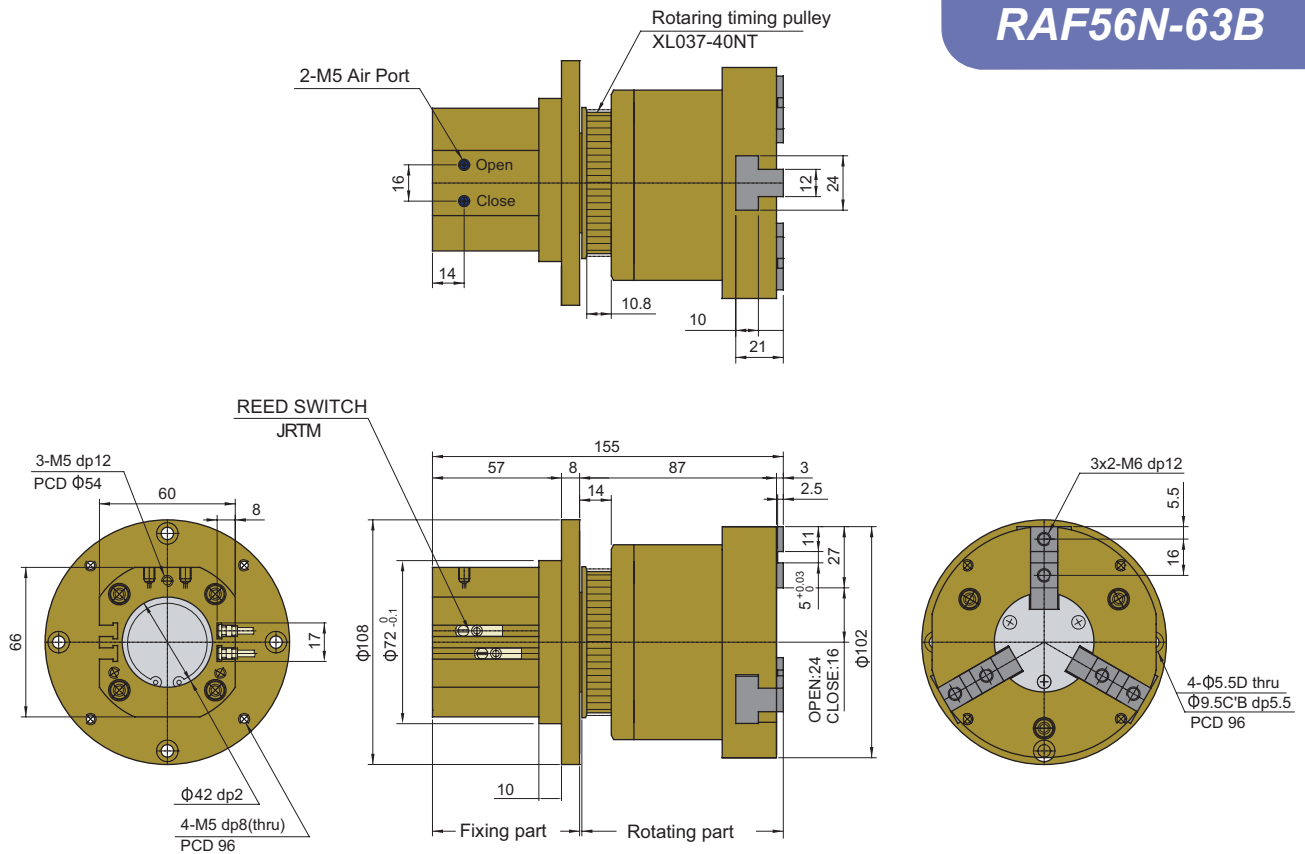

Gripper

MF16-S,M,L

Character

- Normal closing gripper by spring
- High repeatability & long life by jaw united cross roller
- Twisted it is strong hardness plunger
- For precise positioning of individual gripping jaw



Mechanical type

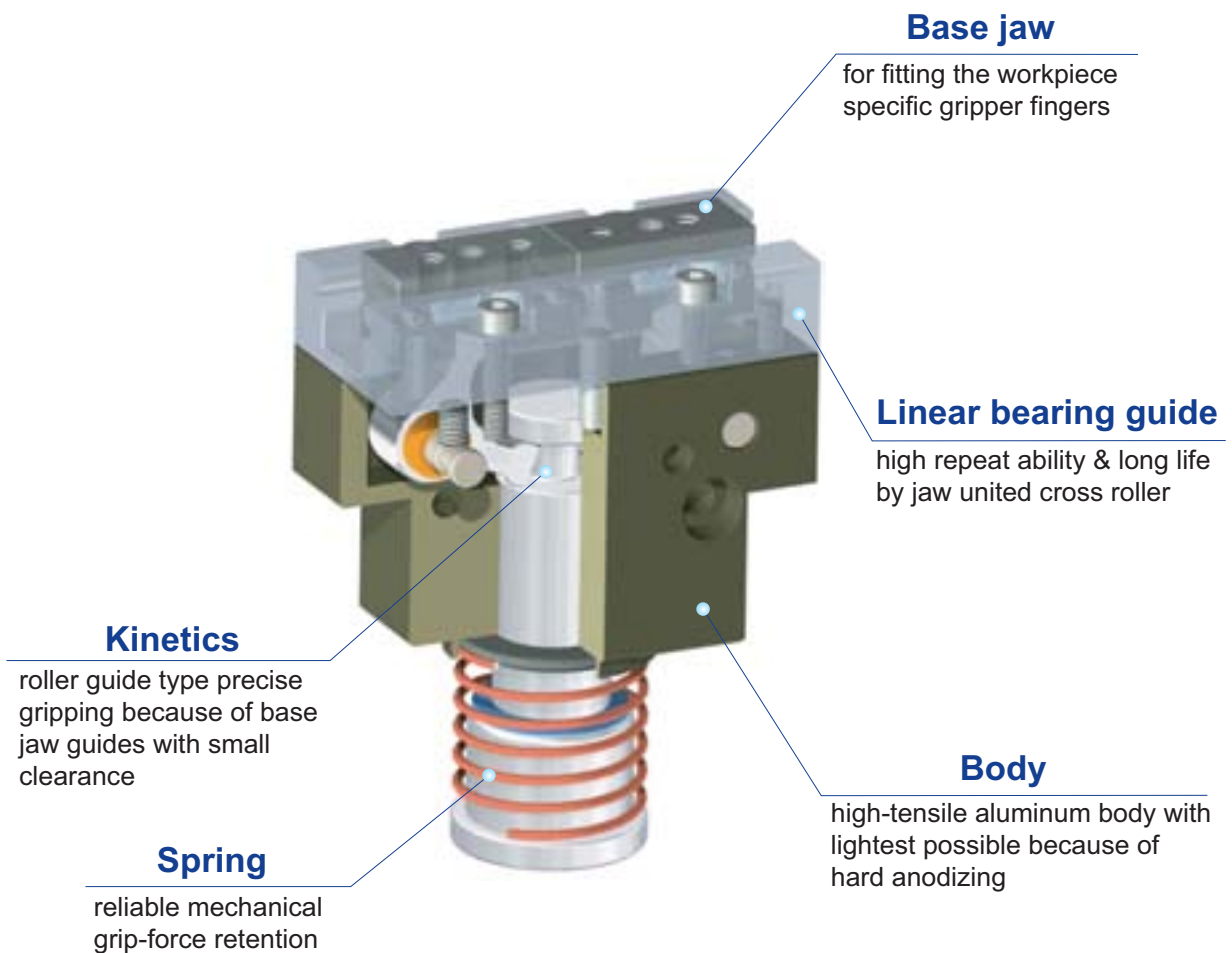

MF16

Exploded view

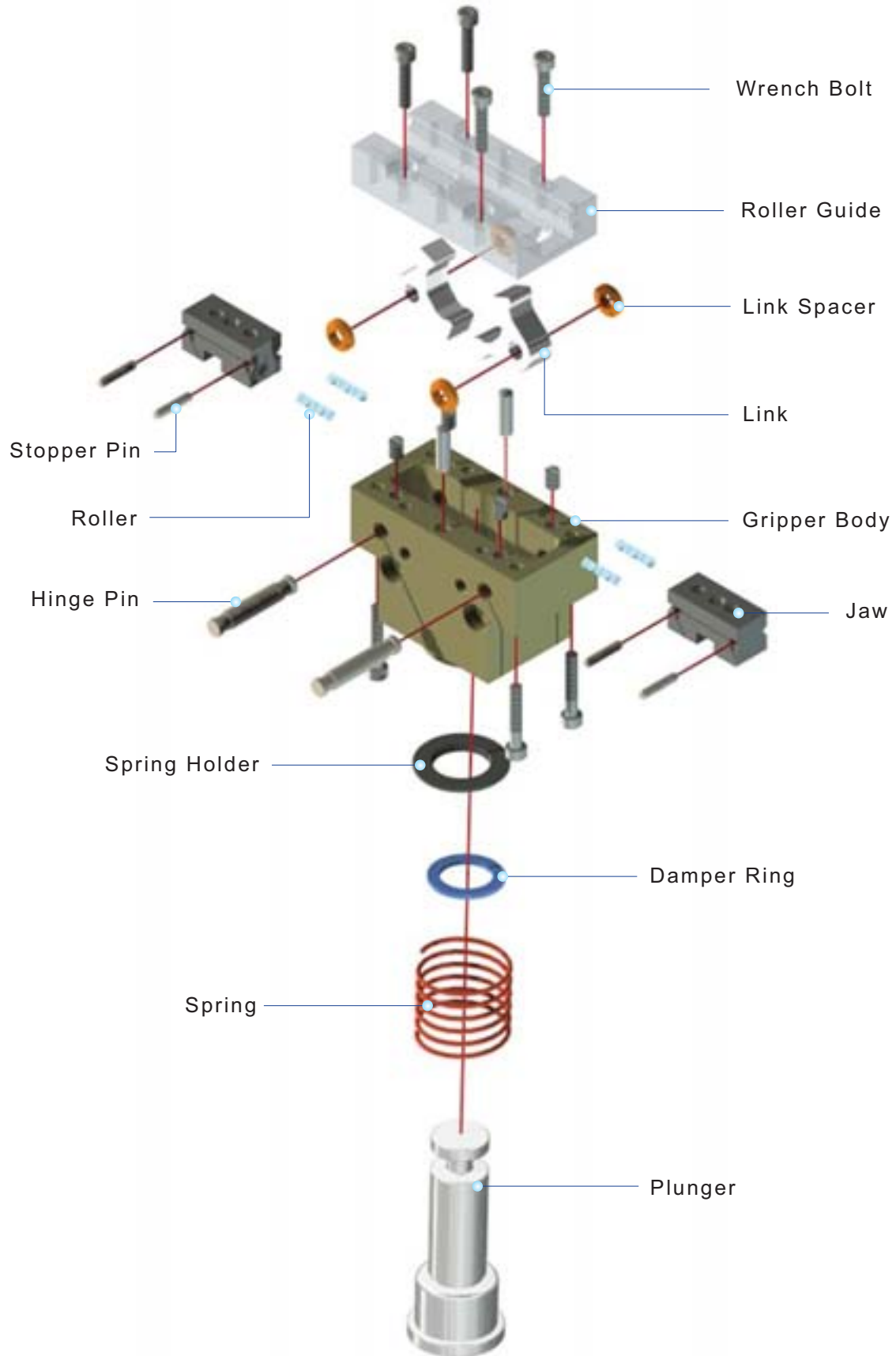

MF16

Ordering Code

MF16 — **M**

①

②

①	Product Name	MF16
②	Size	S, M, L

Specification

Product name	MF16-S	MF16-M	MF16-L	Unit
Stroke	12	14	16	mm
Weight	0.2	0.34	0.5	kg
Max. length of attach	32	40	60	mm
Gripping force:Close	10 to 20	15 to 30	25 to 40	N
Max.cycle per minute	60	50	40	
Ambient temperature	-5 to 60			°C
Lubrication	Needless			

MF16

MF16-S

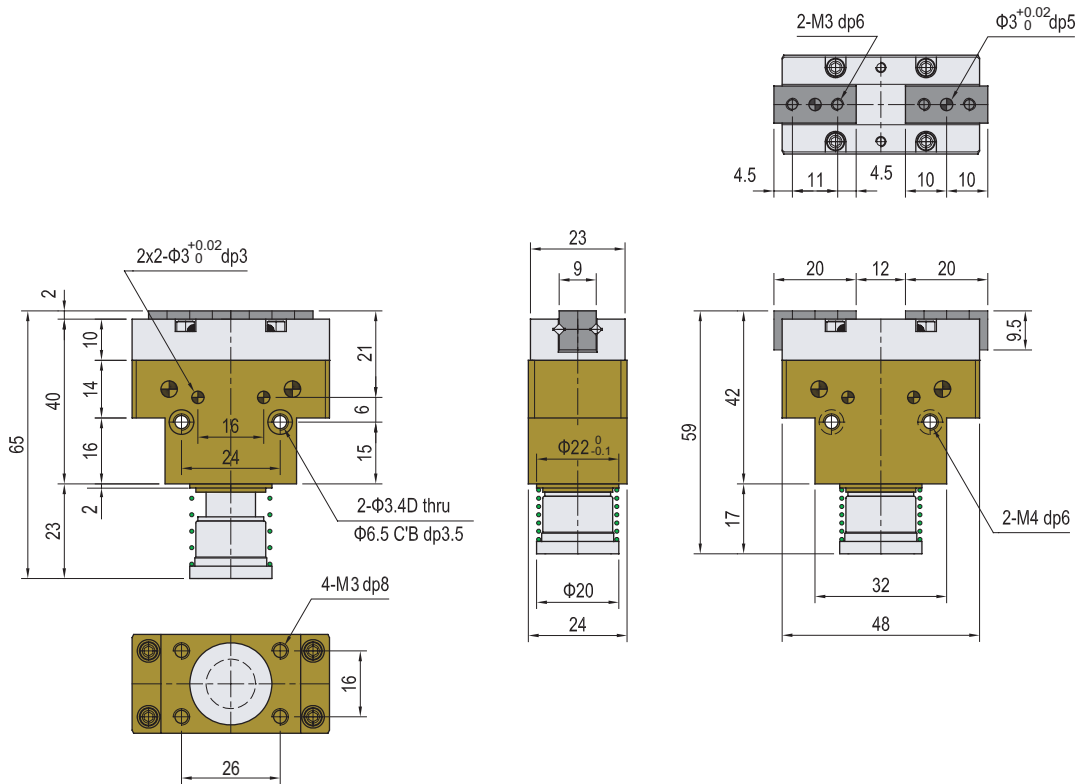

MF16-M

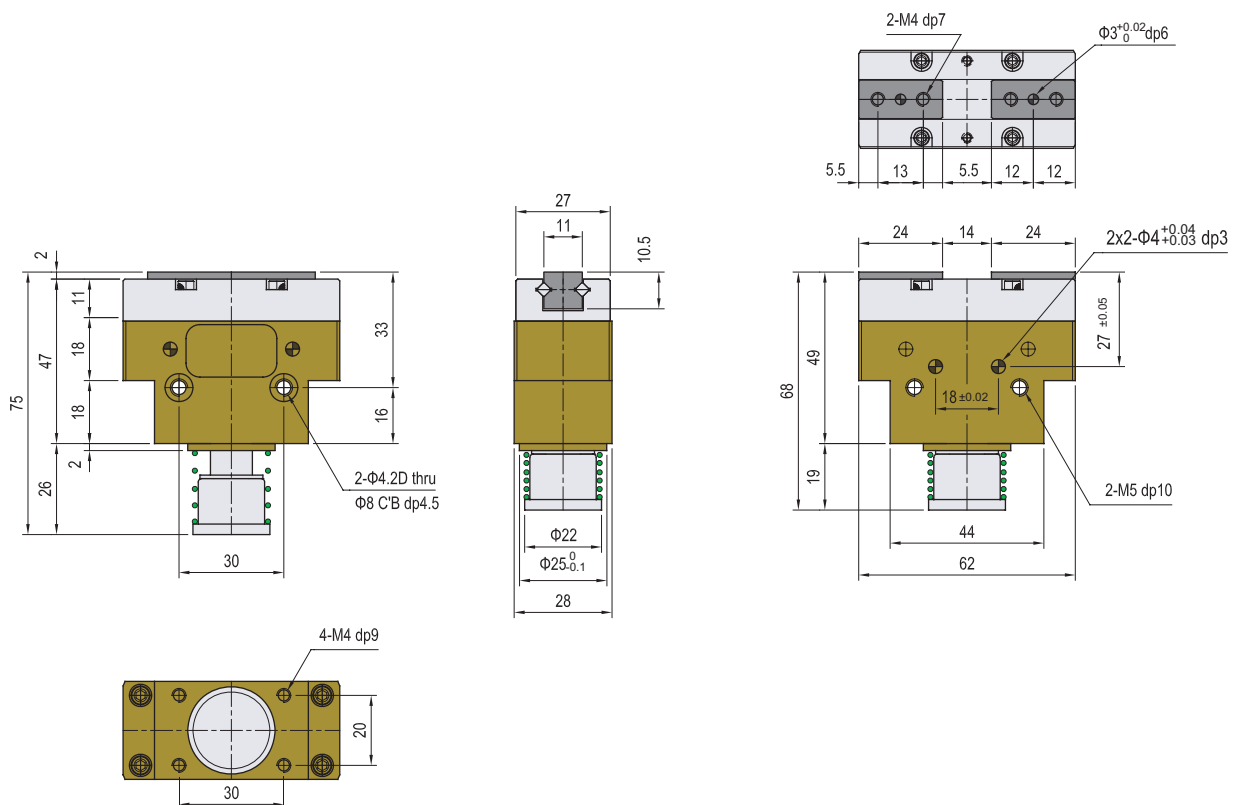

MF16

MF16-L

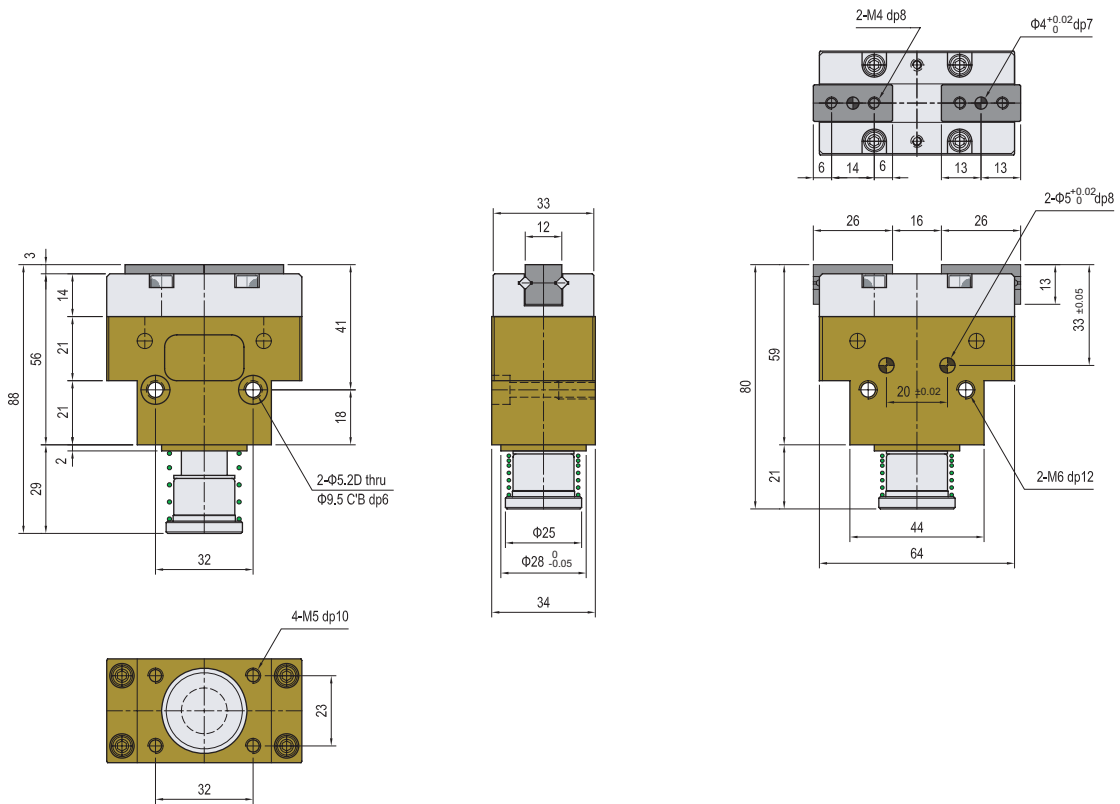

Note

Notes

A large grid of dashed lines for writing notes. The grid consists of 20 columns and 30 rows of squares, with rounded corners on the top and bottom edges. The lines are thin and grey, creating a clean and professional appearance.