



## Energy-efficient strength

Powerful compressed air motors for high torques combined with very low air consumption.

# PTM



mechatronics





Robust motors for extreme environmental conditions and resilient to standstill

# Overview

Powerful compressed air motors for high torques combined with very low air consumption

 <b>BASIC motors</b>	 <b>ATEX motors</b>
For the easy installation in ordinary production environments	For the functionally secure use in hazardous areas

 <b>IP68 waterproof motors</b>	 <b>FDA stainless steel motors</b>
For the use in wet environments and for the durable use in seawater	For the hygienic use in the food sector, also with aggressive substances.

 <b>Ferritfrei</b>
For the use in MRT medical technology and high-frequency technology

Air motor	Nominal torque	Air consumption at 100 revolutions per minute and medium power	Diameter	Height
PMO 450	4 Nm	25 L/min	99 mm	50,5 mm
PMO 900	8 Nm	50 L/min	99 mm	65 mm
PMO 1800	16 Nm	100 L/min	159 mm	67,5 mm
PMO 3600	32 Nm	200 L/min	159 mm	89,5 mm
PMO 7200	65 Nm	450 L/min	159 mm	150,5 mm

# BASIS motors

For the easy installation in ordinary production environments

Our pneumatic radial piston motors are robust, completely mechanical and waterproof products. Therefore, their possible applications are versatile. Due to the radial piston principle our motors reach high torques and low rotational speed even with low air consumption and without transmission. Depending

where they are used, they offer numerous advantages compared to electric motors or vane motors. In many cases they are actually the sole reasonable solution.



- low air consumption
- maximum torque even at low rotational speed
- resilient to standstill
- durable, easy to maintain, very low noise levels
- IP67 waterproof
- hard-coated aluminium housing





Balance systems

Drive of friction wheels

Agricultural machinery

Tension in paper, weaving and winding machines

Commercial vehicles

Closing of screw caps

Drive of conveyor belts

Construction machinery mining,  
processing of lime, plaster, concrete,  
cement



# Stainless steel motors

For the hygienic use, also resistant to aggressive substances

In the food sector great importance is attached to hygiene. Our motors enable a quick and easy cleaning. Additionally, they are highly resistant to aggressive substances. This will not only save you a lot of time but also cumbersome

processes. Our stainless steel model is available in two versions, FDA-compliant air motor with massive stainless steel housing 1.4404 or compressed air motor with stainless steel jacket 1.4571.



- all versions are IP68 waterproof
- available in various sealing concepts (silicone-free, viton, acetone-resistant)



food processing machines

packaging machines

filling lines, breweries

bakery machines

chocolate agitators

machines in dusty environments,  
e.g. flour dust

mills and handling systems for bulk  
material

milk collection technology

milk processing



# ATEX agitator motors

For the functionally secure use in hazardous areas

Our pneumatic motors are often applied in agitators for varnishes and ground material. Their functional safety provides a worry-free, explosion protected handling.



- ATEX II 2 G/D c T5 100°
- hard-coated aluminium housing with grounding
- oil-free drive
- various sealing concepts (silicone-free, viton, acetone-resistant)

## Exemplary applications

- agitators
- painting technology
- chemical engineering
- mills and grinding plants
- handling systems for bulk material
- chemical process vessels
- processing of paints, varnishes, adhesives, fillers and sealants





# IP68 waterproof motors

For the use in wet environments

Our IP68 motors are absolutely waterproof even under extreme conditions. This means that they can not only be brought into contact with liquids temporarily but can be submerged in water permanently. The same applies to environments with the presence of dust. Our IP68 motors are available in four versions:

- IP68 in aluminium housing
- motors resistant to seawater up to depths of 40 metres



Unsere FDA-Edelstahlmotoren sind ebenfalls IP68 wasserdicht.

## Exemplary applications

- oil rigs
- shipbuilding
- diving devices

## Seawater-resistant pneumatic motors

Our seawater-resistant pneumatic motors withstand the aggressive influence of seawater even under extreme conditions and remain absolutely waterproof. IP68 up to depths of 40m.



# Ferrite-free motors

Robust without iron for high-tech applications

Our ferrite-free motor consists of several non-magnetic materials. Its completely mechanical design prevents interference potentials caused by electronics or sensors. This ferrite-free drive without magnetic fields is used for high-frequency and magnetic resonance applications in MRT-devices, for mine detectors and TESLA applications.

## Exemplary applications

- medical technology MRT-devices
- mine detectors
- High-frequency applications
- TESLA

**ferrite  
free**

- without magnetic fields
- only non-magnetic components
- use in large-scale magnetic fields possible
- no interference potentials by electronics or sensors

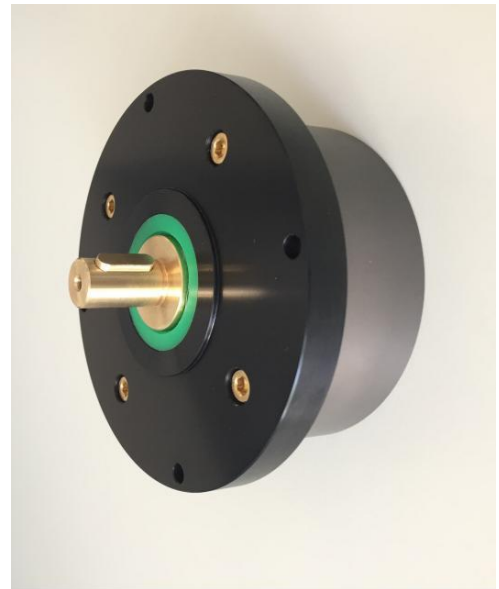

# Accessories

Our all-round carefree package





Via our wide-ranging modular system and numerous options we can adjust our range to every application.

Do you wish to receive an offer, CAD data or a customised solution? We will be happy to advise you. Please contact us:

Phone: +49-8134-25797-0

Email: [info@ptm-mechatronics.com](mailto:info@ptm-mechatronics.com)

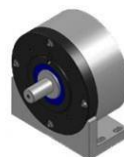

Optional	ATEX Certification	
	Transmission 3:1   9:1   1:2	
	Speed control	
	Silicone-free	
	Viton FPM FKM	
	Acetone-resistant EPDM PTFE	
Accessories	Mounting bracket	
	Mounting flange	
	Adapter for air connection 45° and 90°	
	Various drive shafts	

# Technical data

## Power and weight

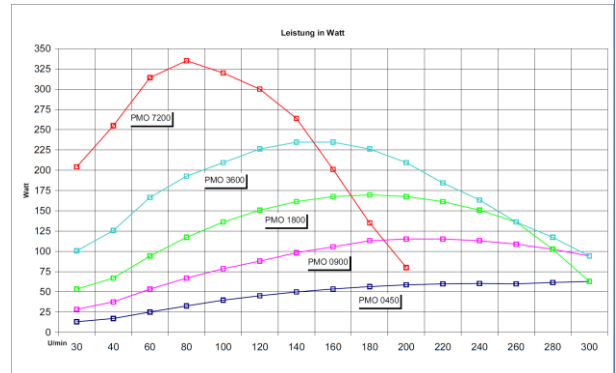
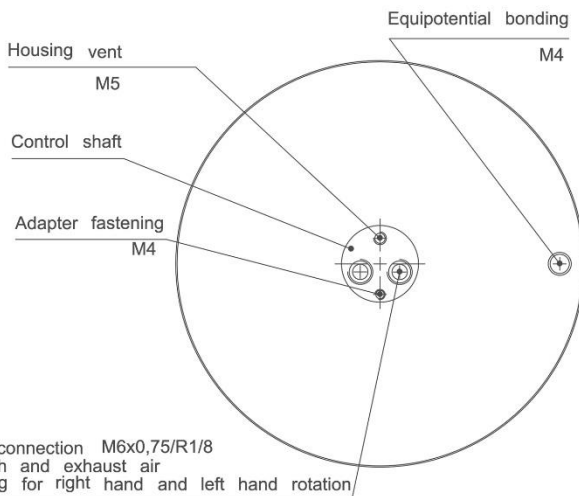
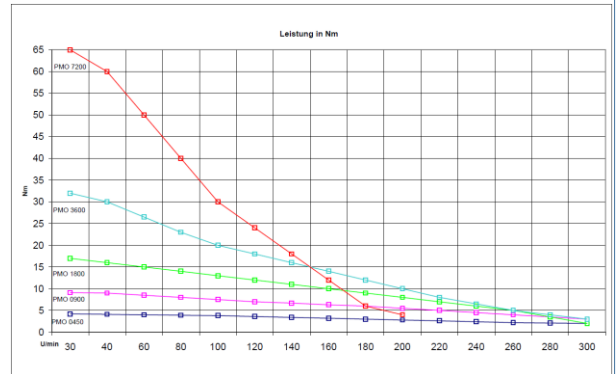
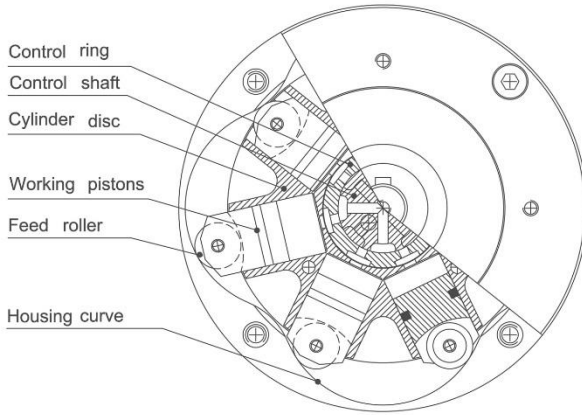

	max. allowed axial loading	radial dyn. C	radial stat. Co	max. allowed radial loading	weights without gear	weights with 3:1 gear	weights with 9:1 gear	weights with 1:2 gear
PMO 0450	100 N	750 N	400 N	5 Nm	1,10 Kg	2,00 Kg	2,80 Kg	2,10 Kg
PMO 0900	100 N	750 N	400 N	5 Nm	1,30 Kg	2,20 Kg	3,00 Kg	2,30 Kg
PMO 1800	200 N	1500 N	800 N	10 Nm	3,40 Kg	6,10 Kg	7,90 Kg	5,90 Kg
PMO 3600	200 N	1500 N	800 N	10 Nm	4,00 Kg	6,70 Kg	8,50 Kg	6,50 Kg
PMO 7200	200 N	1500 N	800 N	10 Nm	6,40 Kg	9,10 Kg	10,90 Kg	8,90 Kg



# Technical data

## Motors without gear

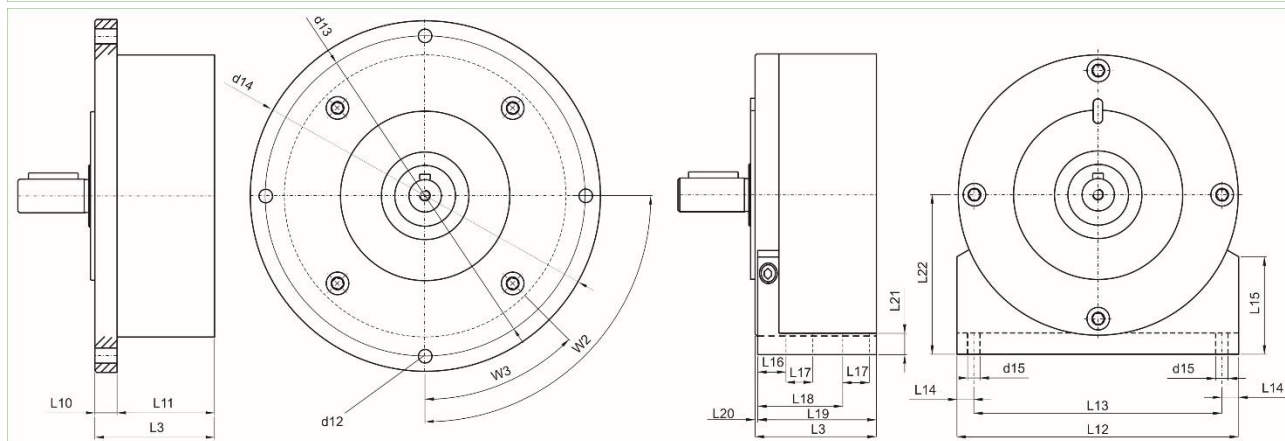
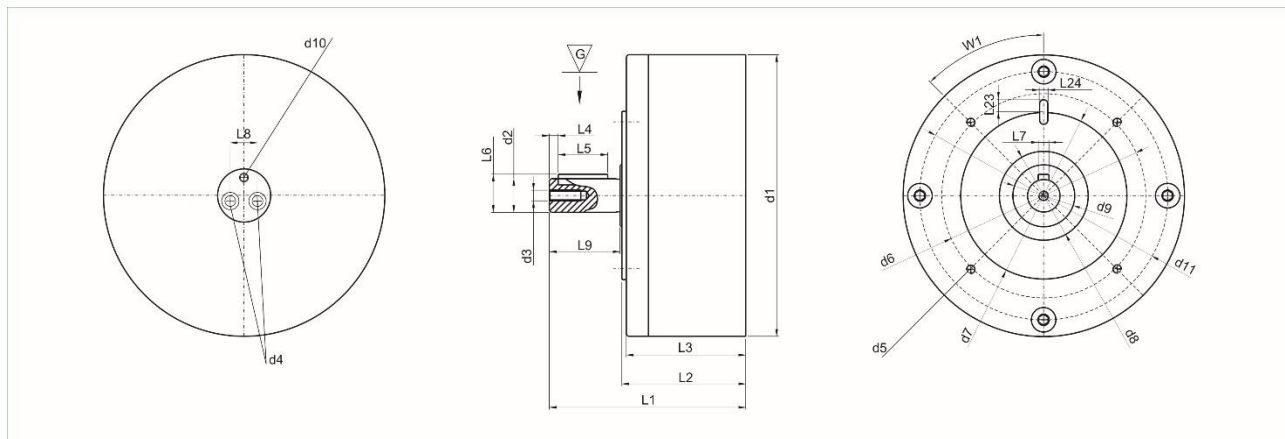

	d 1	d 2	d 3	d 4	d 5	d 6	d 7	d 8	d 9	d 10	d 11	d 12	d 13	d 14	d 15
PMO 0450	99	14 h6	M 4x12	M 6x0,75x8	M 4x9	67	55 h6	40	28	M 5x5	87	5,4	110	120	5
PMO 0900	99	14 h6	M 4x12	M 6x0,75x8	M 4x9	67	55 h6	40	28	M 5x5	87	5,4	110	120	5
PMO 1800	159	19 h6	M 6x18	R1/8x9	M 6x10	115	95 h6	50	35	M 5x5	140	8,5	180	199	7
PMO 3600	159	19 h6	M 6x18	R1/8x9	M 6x10	115	95 h6	50	35	M 5x5	140	8,5	180	199	7
PMO 7200	159	19 h6	M 6x18	R1/8x9	M 6x10	115	95 h6	50	35	M 5x5	140	8,5	180	199	7

	L 1	L 2	L 3	L 4	L 5	L 6	L 7	L 8	L 9	L 10	L 11	L 12	L 13	L 14
PMO 0450	78	52	51	3	18	16	5 N9	11	25	12	39	99	89	5
PMO 0900	93	67	65	3	18	16	5 N9	11	25	12	54	99	89	5
PMO 1800	111	70	68	5	28	22	6 N9	15	40	13	55	159	140	9,5
PMO 3600	133	92	90	5	28	22	6 N9	15	40	13	77	159	140	9,5
PMO 7200	194	153	151	5	28	22	6 N9	15	40	13	138	159	140	9,5

	L 15	L 16	L 17	L 18	L 19	L 20	L 21	L 22	L 23	L 24	W 1	W 2	W 3
PMO 0450	40	15	10	37	50	0,5	10	58	6	4 N9	45°	90°	45°
PMO 0900	40	15	10	37	50	0,5	10	58	6	4 N9	45°	90°	45°
PMO 1800	55	16	15	48	67	0,5	12	90	7	5 N9	45°	90°	45°
PMO 3600	55	16	15	48	67	0,5	12	90	7	5 N9	45°	90°	45°
PMO 7200	55	16	15	48	67	0,5	12	90	7	5 N9	45°	90°	45°

# Technical data

## Motors with gear



	Without gear		Reduction 3 : 1		Reduction 9:1		Ratio 1:2	
	n min = 30 U/min	n max = 300 U/min	n min = 10 U/min	n max = 100 U/min	n min = 3,3 U/min	n max = 33 U/min	n min = 60 U/min	n max = 600 U/min
PMO 0450	4 Nm	2 Nm	12 Nm	6 Nm	36 Nm	18 Nm	2 Nm	1 Nm
PMO 0900	8 Nm	3 Nm	24 Nm	9 Nm	72 Nm	27 Nm	4 Nm	1,5 Nm
PMO 1800	16 Nm	2 Nm	48 Nm	6 Nm	144 Nm	18 Nm	8 Nm	1 Nm
PMO 3600	32 Nm	3 Nm	96 Nm	9 Nm	288 Nm	27 Nm	16 Nm	1,5 Nm
PMO 7200	64 Nm	6 Nm	194 Nm	19 Nm	576 Nm	54 Nm	32 Nm	3 Nm

### Standard

	3:1				9:1				1:2			
	L 1	L 2	L 3	L 11	L 1	L 2	L 3	L 11	L 1	L 2	L 3	L 11
with gear												
PMO 0450	120	94	93	81	146	120	118,5	107	120	94	93	81
PMO 0900	135	109	107	96	160,5	134,5	133	121,5	135	109	107	96
PMO 1800	161	120	118	105	192,5	151,5	149	136,5	161	120	118	105
PMO 3600	183	142	140	127	214,5	173,5	171	158,5	183	142	140	127
PMO 7200	244	203	201	188	275,5	234,5	232	219,5	244	203	201	188

### With stainless steel jacket VA rust-proof 1.4571

	3:1				9:1				1:2			
	L 1	L 2	L 3	L 11	L 1	L 2	L 3	L 11	L 1	L 2	L 3	L 11
with gear												
PMO 0450	123	97	95,5	84	149	123	121,5	110	123	97	95,5	84
PMO 0900	137,5	111,5	110	98,5	163,5	137,5	136	124,5	137,5	111,5	110	98,5
PMO 1800	165	124	121,5	109	196,5	155,5	153	139,5	165	124	121,5	109
PMO 3600	187	146	143,5	131	218,5	177,5	175	162,5	187	146	143,5	131
PMO 7200	248	207	204,5	192	279,5	238,5	236	223,5	248	207	204,5	192

# Technical data

## Stainless motors

	D1	D13	d14	L1	L2	L3	L11
PMO 0450	104	115	124	81	55	53,5	42
PMO 0900	104	115	124	95,5	69,5	68	56,5
PMO 1800	164	180	199	115	74	71,5	59
PMO 3600	164	180	199	137	96	93,5	81
PMO 7200	164	180	199	198	157	154,5	142

## Advantages to electric motor:

- waterproof
- resilient to standstill
- easy frequent load change
- lower weight and smaller installation dimensions
- easy change of rotation direction
- lower heat development
- higher efficiency
- lower susceptibility to heat, vibration and blows
- higher operational safety due to its robust completely mechanical design

## Drive shafts

	d2	L4	L5	L6	L7	D2	L6-2	L7-2
PMO 0450	19h6	2	22	21,5	6N9	24h6	27	8N9
PMO 0900	19h6	2	22	21,5	6N9	24h6	27	8N9
PMO 1800	24h6	2	38	27	8N9	32h6	35	8N9
PMO 3600	24h6	2	38	27	8N9	32h6	35	8N9
PMO 7200	24h6	2	38	27	8N9	32h6	35	8N9

## Advantages to vane motor:

- higher torques
- lower air consumption
- low rotational speed without transmission possible
- resilient to standstill
- higher efficiency
- compact design

Cost savings of €540 per year.

Amortisation of the whole acquisition within 1 year.

Vane motor 35.000 L/h 591€/Jahr.

PTM PMO 1800 3.000 L/h 51€/Jahr.

Bei 30-45U/min 14-15Nm 0,0088 €/m<sup>3</sup> 8h/Tag

# Technical data

## Speed - Power - Air consumption

All our motors achieve maximum torque at the lowest speed (30rpm). Also air consumption is smallest. The maximum speed is 300 rpm and should not be exceeded. The performance potential, as well as the measured air consumption in the various speed ranges is easy to determine from the graphs of the individual motors.

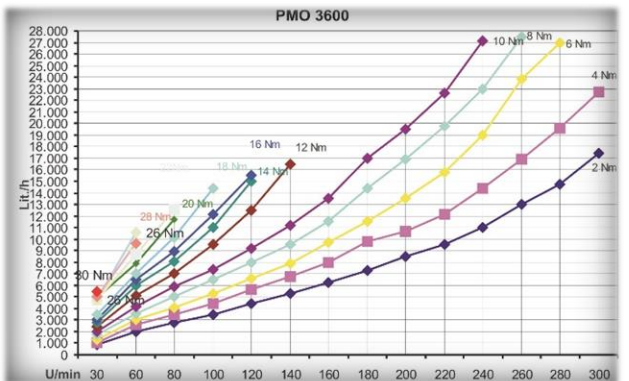
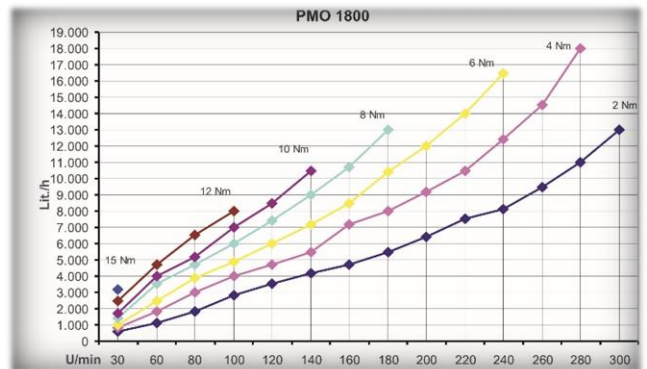
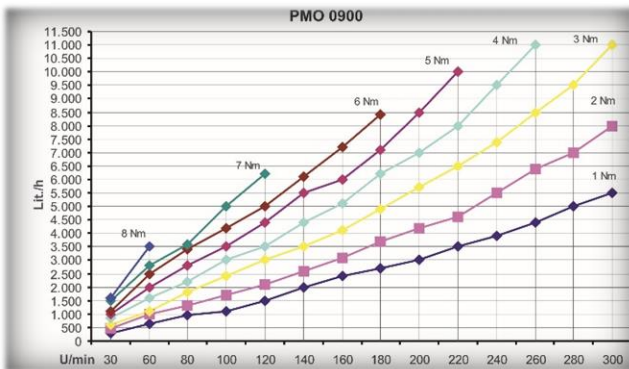
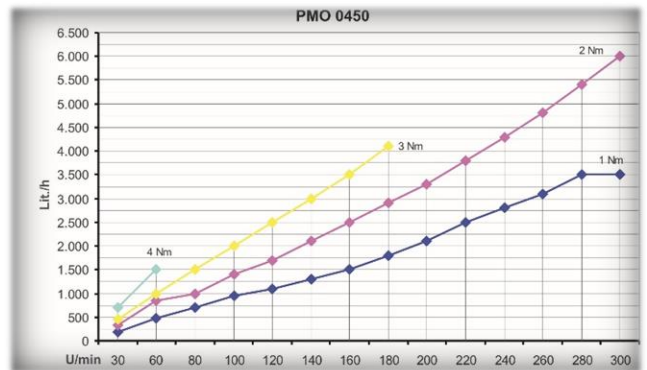
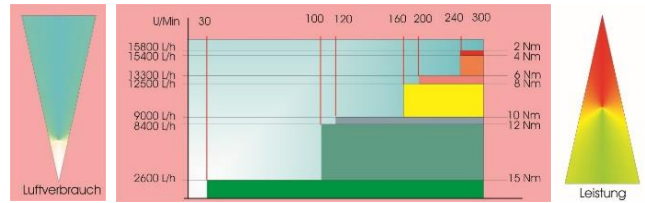



Further products of PTM mechatronics GmbH

**PTM**  
mechatronics

Designed,  
developed and  
made in Germany

leistungsstarke  
**Druckluftmotoren**



powerful  
**air motors**



präzise  
**Greifsysteme**

precise  
**gripping systems**



pneumatische  
**Antriebstechnik**

pneumatic  
**drive technology**

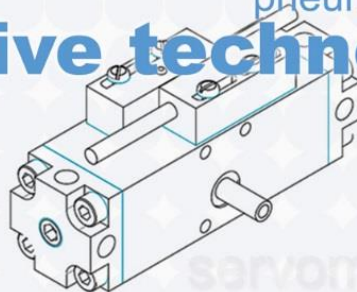

[www.ptm-mechatronics.com](http://www.ptm-mechatronics.com)

# Endlessly in motion

Pneumatic rotary drives with maximum longevity and maintenance-free use

Our pneumatic rotary drives are designed for a maintenance-free long-term operation thanks to their precise guidances and bearings. Small in size, they manage extremely high torques by means of a special rack-and-pinion drive.

- maintenance-free
- exact middle position optional
- position damping optional
- digital end position control optional

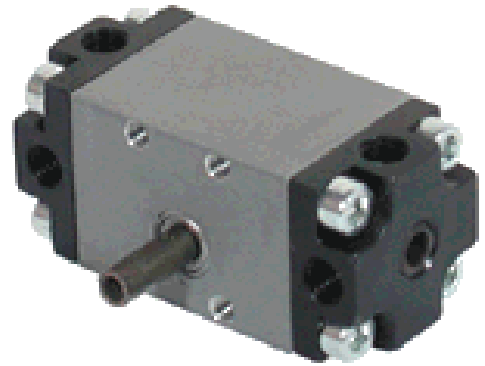

	Rotation angle	Weight	Torque	FA	CO
DA 20	95° 185° 365°	50 g 69 g 75 g	20 Ncm	20 N	90 N
DA 50	95° 185° 365°	100 g 120 g 150 g	50 Ncm	55 N	220 N
DA 200	95° 185° 365°	250 g 330 g 400 g	200 Ncm	180 N	770 N
DA 500	95° 185° 365°	800 g 1000 g 1300 g	500 Ncm	470 N	1900 N
DA 1500	95° 185° 365°	1560 g 1900 g 2200 g	1500 Ncm	550 N	2200 N
DA 3000	95° 185° 365°	2700 g 3200 g 4500 g	3000 Ncm	1000 N	6550 N
DA 6000	95° 185° 365°	4600 g 5500 g 7200 g	6000 Ncm	5000 N	10.000 N

Optional	Precise middle position
	Digital end position control
	End position damping
	1 shaft end
	2 shaft ends
	Drive shaft with tongue and groove
	Drive shaft smooth
Accessories	Limit switch with LED display

# Everything under control

## Hydropneumatic rotary drives with controllable speed and damping characteristic

Our hydropneumatic drives HPA enable the individual adjustment of speed and damping for your application. This makes our hydropneumatic drives unique in the world. Our secret is the combination of an easy pneumatic control by the use of the „clean“ medium compressed air with the advantages of the characteristics of hydraulic oil within a closed system. Consequently, rotary tables can simply be controlled pneumatically without the need for a hydraulic unit.

- maintenance-free
- controllable speed
- damping path and characteristic adjustable



	Rotation angle	Weight	Torque	FA	CO
HPA 750	95° 185° 365°	2,5 kg 2,6 kg 2,9 kg	750 Ncm	1250 N	5000 N
HPA 1500	95° 185° 365°	3,4 kg 3,9 kg 4,4 kg	1500 Ncm	1750 N	7000N
HPA 3000	95° 185° 365°	5,8 kg 6,4 kg 6,9 kg	3000 Ncm	5000 N	10000N

Optional	Digital end position control
	1 shaft end
	2 shaft ends
	Drive shaft with tongue and groove
Accessories	Drive shaft as hollow shaft
	Limit switch with LED display
	Reception flange

Your local contact person: