



***Compact installation unit
reduces logistics costs
and assembly effort***

- Return filter for DIN elements up to NG 100
- Three ports for return line
- Filling port with quick coupling
- Filling control as option available
- Optical / electronical monitoring of the return filter
- Sample ports inside the vessel and in return line
- Breather with integrated level and temperature control
- Optional optical monitoring of the breather

Note:
The drawing shows an example of a complete unit. Configure the connections D, E, F and DIN 24557 part 2 as per the description "optional connections". The connections T1, T2, T3, X1, X2 and X3 are prefixed as described below. The return-line filter (without filter element) is part of the basic unit and available in three different nominal sizes.

Dimensions (in mm)

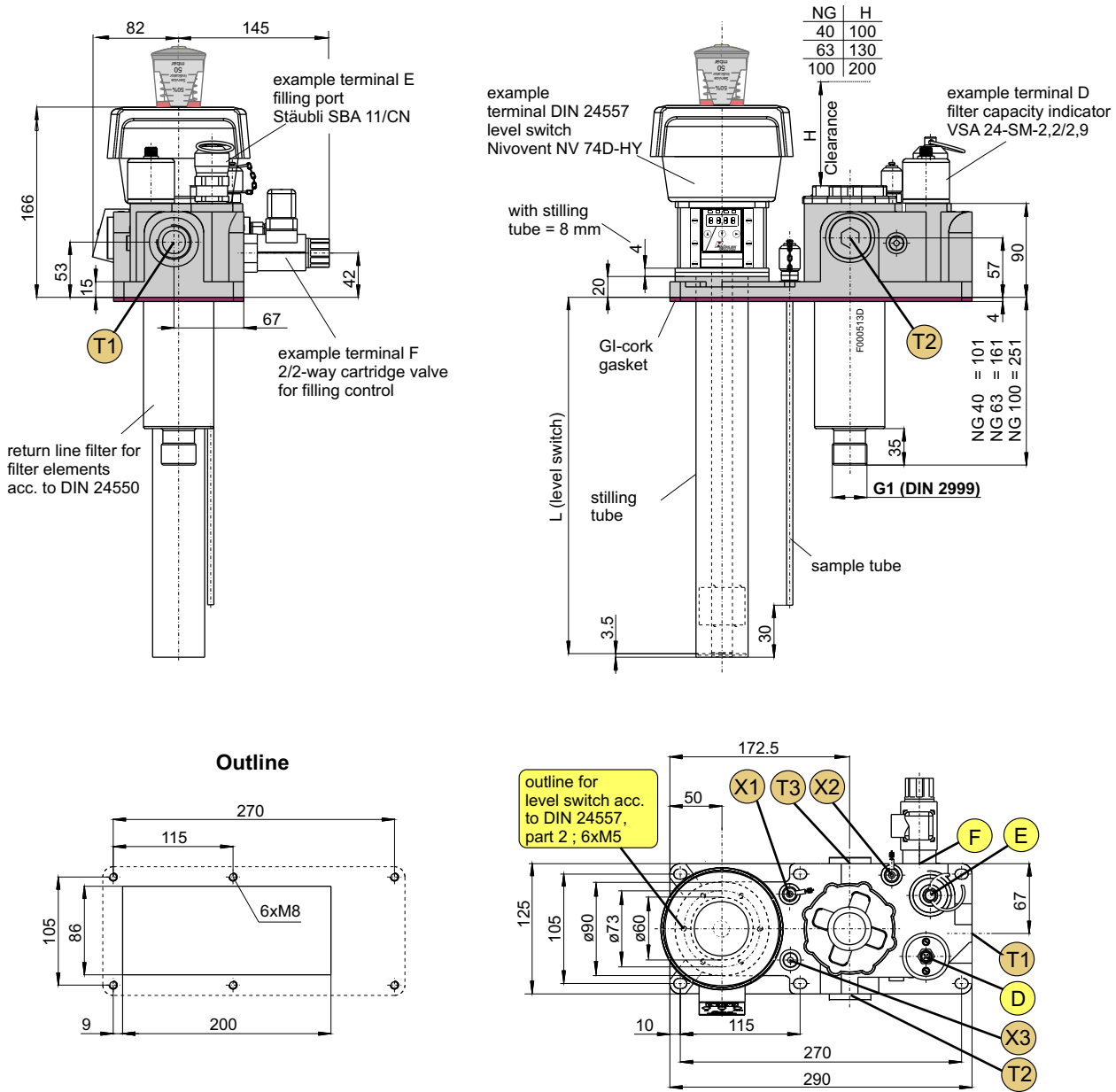

Optional terminals

- D = capacity indicator or sealing plug M30x1,5
- E = filling port G1/2
- F = 2/2-way cartridge valve type Flutec or sealing plug M27x2
- DIN 24557/T2 = 2/2-way cartridge valve type Flutec or sealing plug (other types upon request), on your choice.

Fitted terminals:

- T1 = open connection G1 for return-line filter
- T2 / T3 = sealing plug G1 (alternative connection for return-line filter, connection T1)
- X1 = sample port G1/8, minimes with pipe for probe reservoir
- X2 = sample port G1/8, minimes for probe return line
- X3 = sealing plug G1/8 (alternative connection for X1)

(The connections at T1, T2 and T3 as well as X1 and X3 may be configured by the customer.)

Operating pressure

(return line) max. 10 bar
 operating temperature max. 80 °C

Material

base plate GK-AISi12
 gasket GI-cork
 filter cap and -housing plastic

Return filter

bypass relieve pressure Δp 3.5 bar $\pm 10\%$
 nominal size NG 40, NG 63 or NG 100
 for filter elements according to DIN 24550

Weight

basic unit approx. 3.5 kg

Terminal D - capacity indicator or sealing plug

Type Mahle PIS 3085 / 2,2
 max. operating voltage 250 V AC / 200 V DC
 max. current 1 A
 max. contact load 70 W
 nominal pressure 10 bar /
 temperature range -10 bis +80°C
 indicator setting 2,2 bar
 indication visuall / electrical
 protection class IP65 (plugged)
 contact NO / NC
 connector DIN EN 175301-803, PG11
 material PA 66 / PA 6

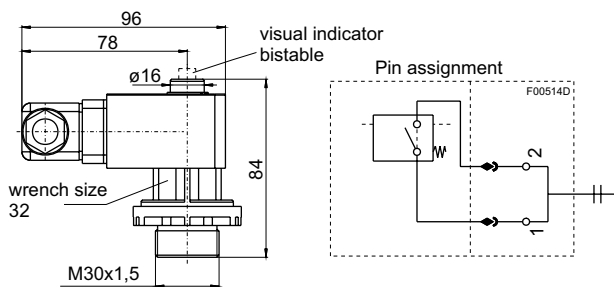

Type Bühler VSA 24-SM-2,2/2,9
 - self-monitoring -
 max. operating voltage 24 V DC $\pm 10\%$
 max. current 1 A at 24 V DC
 max. pressure 10 bar
 indication optical (LED) / electrical
 1. indication (alert) 2.2 bar
 2. indication (shut off) 2.9 bar
 operation temperature -20 °C to 70 °C
 cold start suppression to 30°C (temperature of medium)
 connector M12x1 Socket (5-pol)
 protection class IP67 (with plug installed)
 material Al / PC

See also data sheet DE 13 0002 in chapter 11

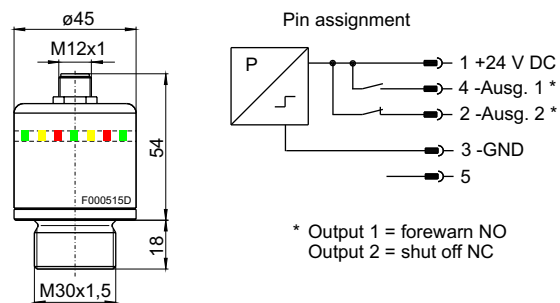

Terminal E - filling port or sealing plug

Type Stäubli SBA 11/CN (plug)
 nominal size 11
 thread G 1/2
 material chrome steel / hardened steel

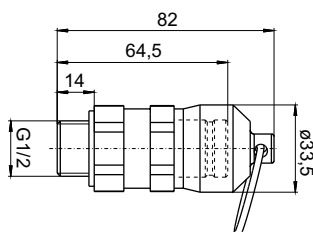

Type Walther MD-012 (Coupling)
 nominal size 12
 thread G 1/2
 material galv. steel / browned

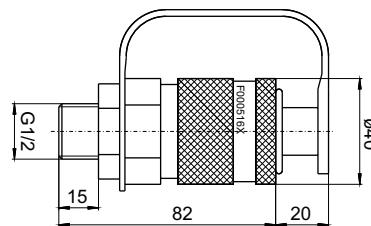

Terminal F - 2/2-way cartridge valve for filling control or sealing plug

General description of filling control:

The 2/2-way cartridge valve automatically stops filling at maximum level. This is provided by the highest level contact at Lx. At power-up of the unit the valve position will change to "b". This means the flow path from 2 to 1 is open and filling is in process. When the fluid level reaches the highest level contact (normally open contact at position Lx), the valve will switch to position "a". The path from 2 to 1 is closed now. The valve blocks the flow from the filling port to the reservoir.

During operation a second level contact (NO/closer at L1) signals a lack of oil. Using an external control a refill of the tank can be made automatically via the filling terminal or the maintenance personnel can be called to do this. In both cases the filling valve will be reset to position "a" as soon as level Lx is reached.

The controller together with a level switch type NV7x (except NV 73) of your choice can be supplied by Bühler Technologies on request.

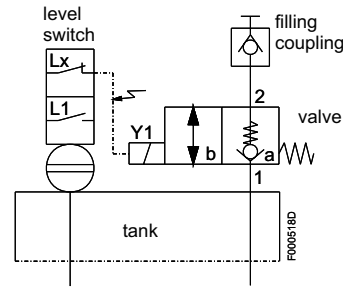

Type	Flutec (2/2-way cartridge valve)
Q max.	100 l/min
p max.	280 bar
nominal voltage	24 V DC (-5/+10%)
nominal current	1.04 A
protection class	IP65
temperature range of medium	min. -20 °C, max. +80 °C
viscosity range	min. 10 mm ² /s, max. 380 mm ² /s
connector	DIN EN 175301-803, PG11

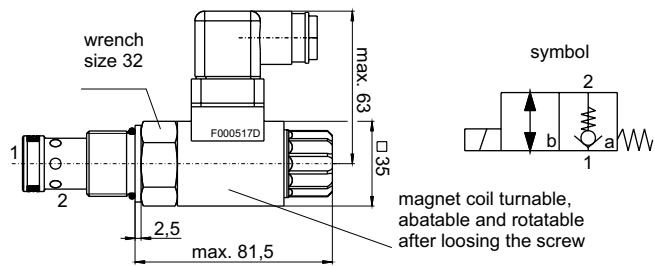

For hydraulic oil according to DIN 51524 part 1 and 2.
Max. pollution degree of fluid acc. to NAS 1638 class 10.

Accessories - DIN-Filter Elements

NG 40

Part No.:	Filter element
100 10 040 10	N 0040 RN 10
100 10 040 25	N 0040 RN 25

NG 63

Part No.:	Filter element
100 10 063 10	N 0063 RN 10
100 10 063 25	N 0063 RN 25

NG 100

Part No.:	Filter element
100 10 100 10	N 0100 RN 10
100 10 100 25	N 0100 RN 25

Performance of return filter

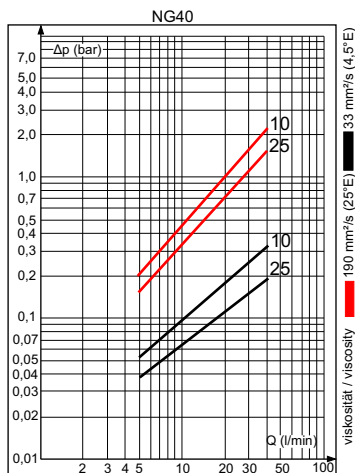

F000525X

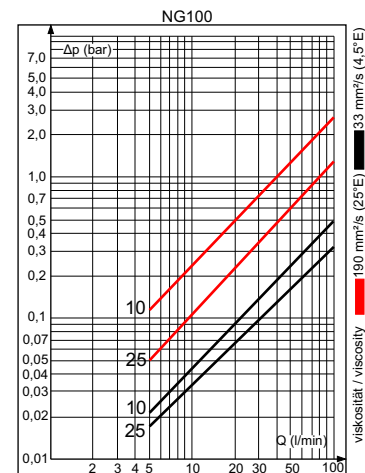
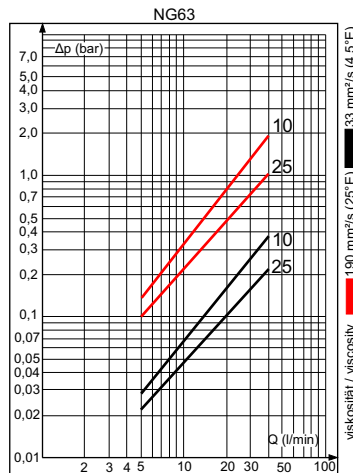

Terminal DIN 24557, Part 2
Breather filter or
Level / temperature switch with breather filter

General note

The Multiterminal if equipped with a level & temperature switch at this terminal is always composed of two parts. The part is the Multiterminal MT described in this data sheet and the second part is the level switch of series NV 7 (see example for order below). An overview of appropriate level switches is given on page 6. Please refer to the corresponding data sheet of the level switch for detailed information and configuration. (Integrated filling control on request).

Basic unit Multiterminal equipped as:
 Multiterminal block, gasket, connection T1-T3, X1-X3 pre-set as described on page 2

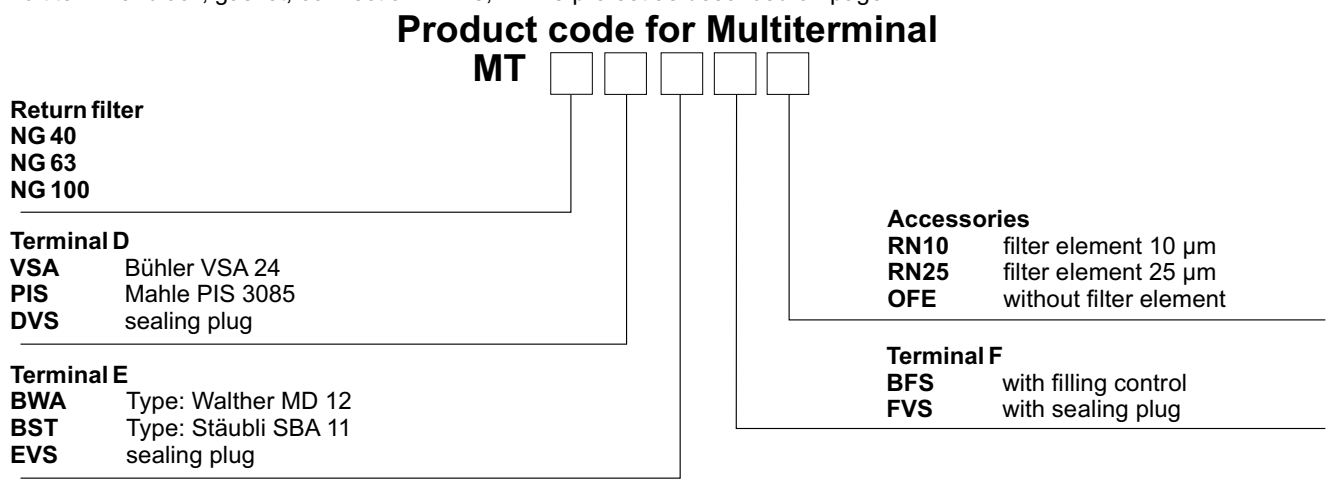

Example for order:

You need:
 Basic unit Multiterminal NG 63, optional connectors as follows:

- | | |
|------------------------|---|
| Terminal | |
| D (capacity indicator) | = Bühler VSA 24-SM-2,2/2,9 |
| E (filling port) | = Walther MD-012 |
| F (filling control) | = sealing plug M27x2 |
| accessories | = Filter element N 0063 RN 10, retention rate 10 µm |

You order:
MT NG 63-VSA-BWA-FVS-RN10

Terminal DIN 24557 Teil 2 (level- / temperature switch with breather filter)

Example

Level switch Nivovent NV 74 for Multiterminal, brass, length L = 370 mm (measured from bottom edge of the Multiterminal base plate), connector M12, one level contact at L1=190 mm NC, one temperature contact at 60°C as NC and breather filter with visual clogging indicator.

You order:
NV 74-HY-MS-M12-/370-1K-TK60NC-MT-VS
 L1 = 190 mm NC

Level switch: **NV 74 for Multiterminal**

- For technical data please refer to data sheet DE 10 0205

- Hydac breather filter
- quick and easy adjustable level contacts
- plug in plug system
- up to 4 contacts
- bi-metal contacts, Pt 100 or 4-20 mA signal output for temperature
- **NV 74D equipped with display and control unit**
- easy operation via 3 keys
- good visible LED display
- up to 4 programmable temperature switching outputs
- optional continuous temperature output signal, programmable 4-20 mA, 0-10 V or 2-10 V

easyjust



Level switch: **NV 71 for Multiterminal**

- For technical data please refer to data sheet DE 10 0204

- Hydac breathing filter
- Level and/or temperature control
- up to 4 contacts
- 230 V applicable
- bi-metal contacts, Pt 100 or 4-20 mA signal output for temperature
- **NV 71D equipped with display and control unit**
- easy operation via 3 keys
- good visible LED display
- up to 4 programmable temperature switching outputs
- optional continuous temperature output signal, programmable 4-20 mA, 0-10 V or 2-10 V



Level switch: **NV 73 for Multiterminal**

-For technical data please refer to data sheet DE 10 0206

- **continuous level measurement**
- Hydac breathing filter
- alternatively with continuous temperature measurement, 4-20 mA output
- resolution 5 mm
- diverse connectors
- immersion depth up to 1420 mm (longer upon request)



Level switch: **NV 77-XP for Multiterminal**

- For technical data please refer to data sheet DE 10 0203

- **continuous level measurement**
- Hydac breathing filter
- 4-20 mA output
- resolution 5 mm
- immersion depth up to 1420 mm
- **display and control unit**
- 4 switching outputs programmable as level or temperature output
- alternatively 2 switching outputs programmable as level or temperature output plus 1 analogue output each for continuous analogue output for level and temperature control
- analogue output programmable as 4-20 mA, 0-10 V, 2-10 V or 0-5 V
- display of actual values for level or temperature switchable

